



TeraOhm 5kV Plus
MI 3201
User Manual
Version 1.7 Code No. 20 751 272

Distributor:

Producer:

METREL d.d.
Ljubljanska 77
SI-1354 Horjul

Tel.: +386 1 75 58 200
Fax: +386 1 75 49 226
E-mail: metrel@metre.si
<http://www.metrel.si>



Mark on your equipment certifies that this equipment meets the requirements of the EU (European Union) concerning safety and interference causing equipment regulations

© 2008 Metrel

No part of this publication may be reproduced or utilized in any form or by any means without permission in writing from METREL.

Table of contents

1	General introduction	4
1.1	Features	4
1.2	Applied Standards	4
2	Instrument Description	5
2.1	Instrument Casing	5
2.2	Operator's Panel	5
2.3	Connectors	6
2.4	Accessories	7
2.5	Test leads	7
2.5.1	High voltage shielded test tips with High voltage alligator clips	8
2.5.2	Guard test lead with alligator clips	8
3	Warnings	9
4	Performing measurements	11
4.1	Switching on the instrument	11
4.1.1	Configuration	12
4.1.2	Setup	13
5	Measurements	15
5.1	General Information about High DC voltage testing	15
5.2	Guard terminal	19
5.3	Filter options	20
5.4	Voltage measurement	21
5.5	Insulation Resistance measurement	22
5.6	Diagnostic Test	26
5.7	Step Voltage Insulation Resistance testing	32
5.8	Withstanding voltage	36
6	Working with your Results	39
6.1	Storing, Recalling and Clearing Results	39
6.2	Transferring Data to a PC	41
7	Maintenance	42
7.1	Inspection	42
7.2	Inserting and charging batteries for the first time	42
7.3	Replacing and charging batteries	42
7.4	Cleaning	44
7.5	Calibration	44
7.6	Service	44
8	Specifications	45
8.1	Measurement specifications	45
8.2	General specifications	48

1 General introduction

1.1 Features

The **TeraOhm 5kV Plus** Tester is a portable battery / mains powered test instrument intended for the testing of Insulation Resistance by using high test voltages of up to 5kV.

The instrument is designed and produced with the extensive knowledge and experience acquired through many years of working in this sector.

Available functions offered by the **TeraOhm 5kV Plus** Tester:

- High insulation resistance measurement up to 10 TΩ
 - Programmable test voltage from 250 V up to 5 kV, steps 25 V
 - R(t) Graphs
 - Programmable timer (1s up to 100 min)
 - Automatic discharge of test object after completion of measurement
 - Capacitance measurement
- Insulation resistance measurement versus test voltage (step-up voltage test)
 - Five discrete test voltages proportionately set within preset test voltage range
 - Programmable timer 1 min up to 30 min per step
- Polarization Index (PI), *Dielectric Absorption ratio (DAR)* and *Dielectric Discharge (DD) ratio*
 - $PI = R_{INS}(t2) / R_{INS}(t1)$
 - $DAR = R_{1min} / R_{15s}$
 - $DD = I_{dis 1min} / C \cdot U$
- Withstanding voltage (DC) up to 5 kV
 - Programmable ramp test voltage from 250 V up to 5 kV
 - High resolution ramp (approx. 25 V per step)
 - Programmable threshold current up to 5 mA
- Voltage and frequency measurement up to 600 V AC/DC

A dot matrix LCD offers easy-to-read results and all associated parameters. The operation is straightforward and clear to enable the user to operate the instrument without the need for special training (except reading and understanding this Users Manual).

Test results can be stored on the instrument. The new professional PC SW enables straightforward transfer of test results and other parameters in both directions between the test instrument and PC.

1.2 Applied Standards

Instrument operation	IEC / EN 61557-2
Electromagnetic compatibility (EMC)	EN 61326 Class B
Safety	EN 61010-1 (instrument), EN 61010-031 (accessories)

2 Instrument Description

2.1 Instrument Casing

The instrument is housed in a plastic box that maintains the protection class defined in the general specifications.

2.2 Operator's Panel

The operator's panel is shown in **Fig. 1** below.

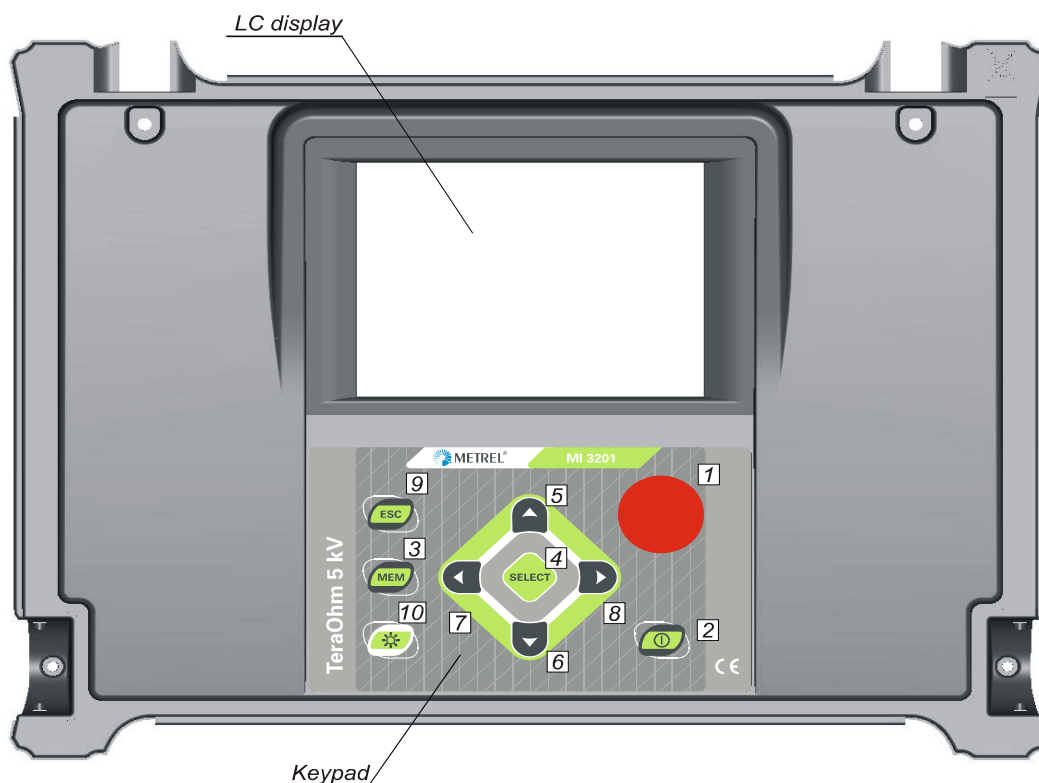

Fig. 1. Front panel

Legend:

- 1..... **START/STOP** key to start or stop any measurement.
- 2..... **ON/OFF** key to switch the instrument ON or OFF.
- 3..... **MEM** key to store, recall and erase results.
- 4..... **SELECT key** to enter set-up mode for the selected function or to select the active parameter to be set.
- 5..... ▲ **cursor** key to select an option upward.
- 6..... ▼ **cursor** key to select an option downward.
- 7..... ◀ **cursor** key to decrease the selected parameter.
- 8..... ▶ **cursor** key to increase the selected parameter.
- 9..... **ESC** key to exit the selected mode.
- 10..... **Light** key to turn the display backlight ON or OFF.

2.3 Connectors

The **TeraOhm 5 kV** Tester contains the following connections:

- Connection of test leads to four banana safety sockets (**Fig. 2**),
- Mains supply cable connection to the mains socket and communication socket (USB and RS232) (**Fig. 3**).

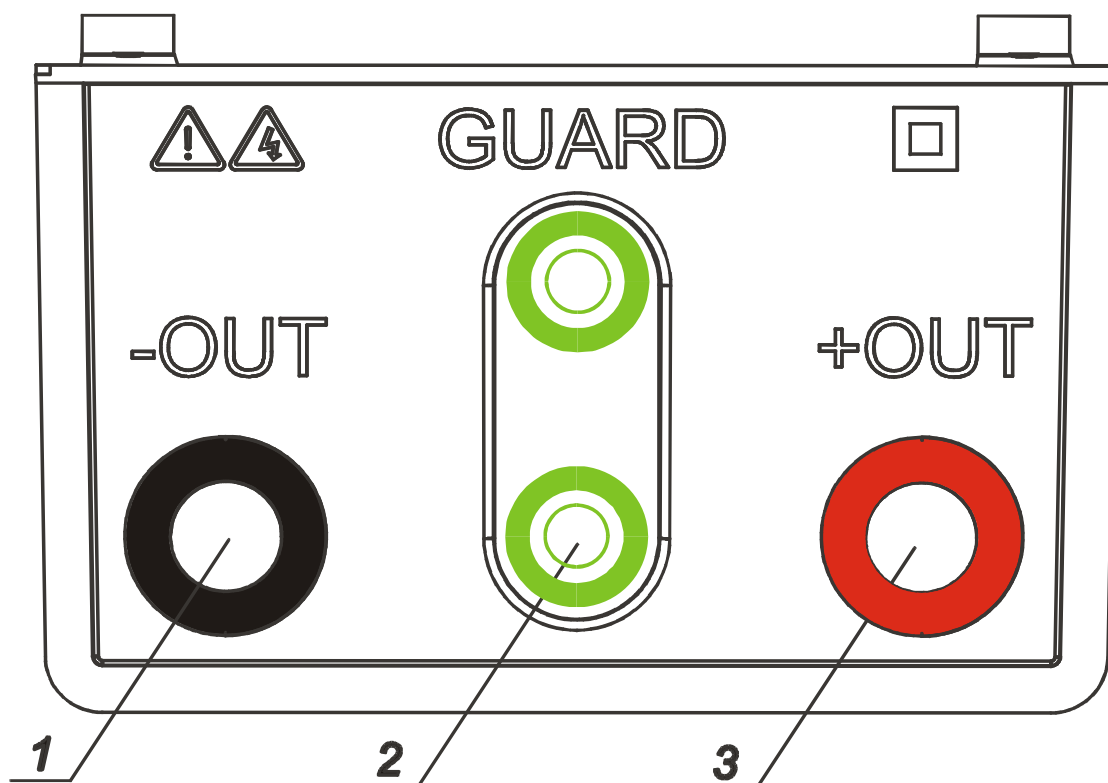

Fig. 2. Test leads connector

- 1..... Negative Insulation Resistance **test terminal**. (-OUT)
- 2..... **GUARD** test terminals intended to lead away potential leakage current while measuring the Insulation. Both green sockets are connected together inside the instrument.
- 3..... Positive Insulation Resistance **test terminal** (+OUT)



Use original test accessories only!
 Max. allowed external voltage between test terminals and ground is 600V!
 Max. allowed external voltage between test terminals is 600V!

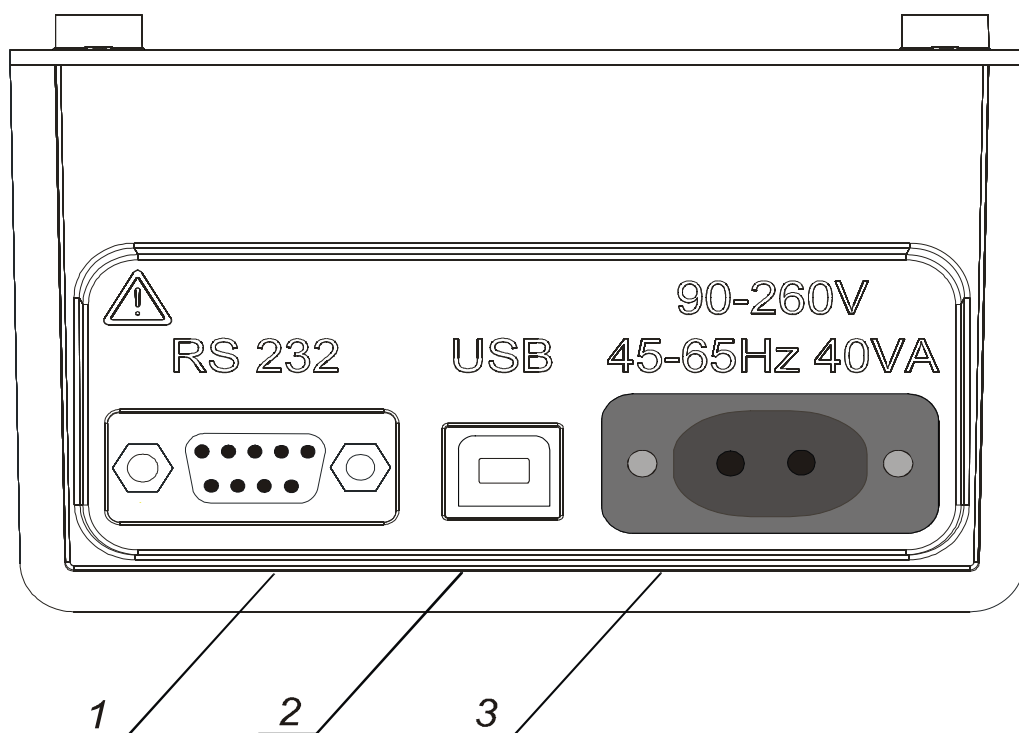

Fig. 3. Communication and Mains connector

- 1..... Galvanic separated **RS232 connector** to connect the instrument to PC.
- 2..... Galvanic separated **USB connector** to connect the instrument to PC.
- 3..... Mains connector to connect the instrument to the mains supply.



Use original mains supply cable only!

2.4 Accessories

The accessories consist of standard and optional accessories. Optional accessories can be delivered upon request. See attached list for standard configuration and options or contact your distributor or see the METREL home page: <http://www.metrel.si>.

2.5 Test leads

The standard length of test leads is 2m, optional lengths are 8m and 15m. For more details see attached list for standard configuration and options or contact your distributor or see the METREL home page: <http://www.metrel.si>.

All test leads are made of high voltage shielded cable, because shielded cable provides higher accuracy and immunity to disturbance of measurements that can occur in industrial environment.

2.5.1 High voltage shielded test tips with High voltage alligator clips

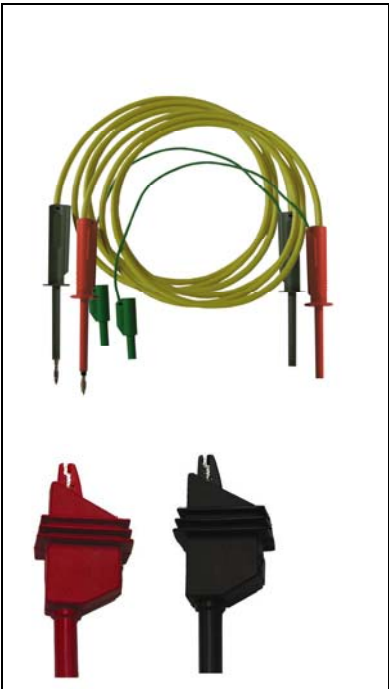
	<p>Application notes: These test leads is designed for diagnostic testing of insulation and also for hand held testing of insulation.</p> <p>Insulation ratings:</p> <ul style="list-style-type: none">- High voltage banana connector (red, black): 5kV d.c (double insulation);- High voltage tip (red, black): 5kV d.c (double insulation);- Alligator (red, black): 5kV d.c (double insulation);- Guard banana connector (green): 600V CAT IV (double insulation);- Cable (yellow): 12kV (shielded).
---	---

2.5.2 Guard test lead with alligator clips



Insulation ratings:

- Guard test lead with banana connectors (green): 600V CAT IV (double insulation);
- Alligator (green): 600V CAT IV (double insulation).

3 Warnings

In order to reach the highest level of operator's safety while carrying out various measurements and tests using the **TeraOhm 5kV Plus** Tester, as well as to ensure that the test equipment remains undamaged, it is necessary to consider the following warnings:

MEANING OF SYMBOLS

	Symbol on the instrument means "Read the User Manual with special care!".
	Symbol on the instrument means "Hazardous voltage higher than 70V may be present at the test terminals!".

GENERAL PRECAUTIONS

- ◆ If the test equipment is used in a manner not specified in this Users Manual, the protection provided by the equipment may be impaired!
- ◆ Do not use the instrument and accessories, if any damage is noticed!
- ◆ Consider all generally known precautions in order to avoid the risk of electric shock while dealing with electric installations!
- ◆ Service intervention or recalibration procedure can be carried out only by a competent and authorized person!
- ◆ Only adequately trained and competent persons may operate the instrument.
- ◆ A dot matrix LCD offers easy-to-read results and all associated parameters. Operation is simple and clear; the operator does not need any special training (except reading and understanding this Users Manual) to operate the instrument.

BATTERIES

- ◆ Disconnect all test leads, main supply cable and switch the power off before opening the Battery cover!
- ◆ Use only NiMh rechargeable batteries (C size)!

EXTERNAL VOLTAGES

- ◆ Do not connect the instrument to a mains voltage different from the one defined on the label adjacent to the mains connector, otherwise the instrument may be damaged.
- Do not connect test terminals to an external voltage higher than 600 V DC or AC (CAT IV environment) to prevent any damage to the test instrument!

WORKING WITH THE INSTRUMENT

- ◆ Use only standard or optional test accessories supplied by your distributor!
- ◆ Equipment under test must be switched off i.e. (de-energized) before test leads are connected to the equipment.

- ◆ Do not touch any conductive parts of equipment under test during the test.
- ◆ Make sure that the tested object is disconnected (mains voltage disconnected) before starting the Insulation Resistance measurement!
- Do not touch the tested object whilst testing it, risk of electric shock!
- In case of a capacitive test object (long tested cable etc.), automatic discharge of the object may not be done immediately after finishing the measurement – “Please wait, discharging” message will be displayed.

HANDLING WITH CAPACITIVE LOADS

- ◆ Note that 40 nF charged to 1 kV or 9 nF charged to 5 kV are hazardous live!
- ◆ Never touch the measured object during the testing until it is totally discharged.
- ◆ Maximum external voltage between any two leads is 600 V (CAT IV environment).

4 Performing measurements

4.1 Switching on the instrument

Auto-calibration

The instrument is switched ON by pressing the **ON/OFF** key. After turning on, the instrument will execute the auto-calibration (**Fig. 4**).

Note:

If batteries are defective or missing and the instrument is powered from mains supply, the instrument will not turn ON.

Measuring test leads should be disconnected during auto-calibration. If not, the auto-calibration procedure could be false and instrument will require disconnection of the test leads and repeat switching OFF and ON.

After finishing the auto-calibration, the **MAIN MENU** (**Fig.5**) will appear and instrument is ready for normal operation.

Auto-calibration prevents the reduction in accuracy when measuring very low currents. It compensates the effects caused by ageing, temperature and humidity changes etc. A new auto-calibration is recommended when the temperature changes by more than 5°C.

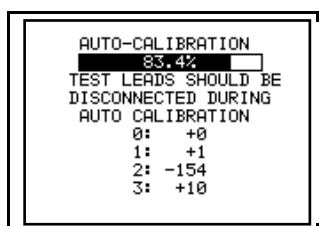

Fig. 4. Auto-calibration state



Fig. 5. Main Menu

Note:

If the instrument detects an incorrect state during the auto-calibration, the following warning message will be displayed:

ERROR!

-TEST LEADS CONNECTED:

DISCONNECT AND SWITCH ON THE INSTRUMENT AGAIN

- CONDITIONS OUT OF RANGE: PRESS START TO CONTINUE

Possible reasons for out of range conditions are excessive humidity, excessively high temperature, etc. In this case it is possible to perform measurements by pressing the START/STOP button again but results could be out of technical specification.

Mains powered instrument operation

If you connect instrument to the mains supply when instrument is turned OFF, internal charger will begin to charge the batteries but instrument will remain turned OFF. In

bottom left angle of LCD screen the plug character and the flashing battery indicator will appear to indicate that the batteries are charging.

Note: If batteries are defective or missing, the charger will not work. In lower left corner of LCD screen only plug character will be appeared (without battery indicator).

If the instrument is connected to the mains supply when the instrument is turned ON, the instrument will automatically switch from the battery supply to the main supply. In bottom left corner of LCD screen, the plug character will appear. If instrument is not in measuring mode*, the internal charger will begin to charge the batteries. In bottom left corner of LCD screen battery indicator will start to flash, indicating that the batteries are charging.

Note: It is not recommended to connect or disconnect the instrument to mains supply while the instrument is in measuring mode*.

*measuring mode: When the instrument is performing a test.

Backlight operation (battery powered instrument)

After turning the instrument ON the LCD backlight is automatically turned ON. It can be turned OFF and ON by simply clicking the **LIGHT** key.

Backlight operation (mains powered instrument)

After turning the instrument ON the LCD backlight is automatically turned OFF. It can be turned OFF and ON by simply clicking the **LIGHT** key.

Off function

The instrument can be switched OFF only by pressing the **ON/OFF** key. The auto-off function is not available to allow long-term measurements to be performed.

4.1.1 Configuration

The configuration function enables the selection and adjustment of parameters (**Table 1a.**) of the measurements. In addition memorized results can be cleared in this menu. (**Fig. 5a**).

In the lower section of the display the power supply status is shown.

The following procedure must be carried out when adjusting some of the configuration parameters:

1. Use ↑ and ↓ arrows to select parameter (line) to be adjusted.
2. Use ← and → arrows to change the value of the selected parameter. If there are two or more sub-parameters in one line (e.g. date and time) then use the **SELECT** key to skip to the next sub-parameters and back.

To clear all memory locations:

1. Select **Configuration** from the main menu
1. Highlight the **Memory Clear** option using ↑ and ↓ arrows.
2. Press the **SELECT** key, (“**Press MEM to confirm!**” message will be displayed).
3. Press the **MEM** key to clear all memory locations or **ESC** to cancel the activity.

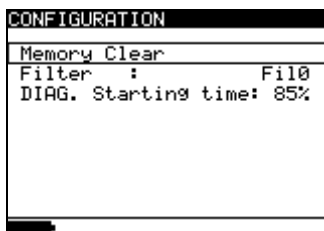

Fig. 5a. Configuration menu

Parameter	Value	Note
Memory clear		Clear all memory locations
Filter	Fil1, Fil2, Fil3, Fil0	Selection of noise rejecting filter, see the chapter 5.3. Filter Option
DIAG. Starting time	0%..90%	Adjustment of start of the timer in the DIAGNOSTIC TEST functions, according to the nominal voltage Unominal. See additional explanation in chapter 5.6.

Table 1a. Parameters in Configuration menu

4.1.2 Setup

The setup function enables the selection and adjustment of general parameters (**Table 1b.**) of the instrument (**Fig. 5b.**).

In the lower section of the display the power supply status is shown.

The following procedure must be carried out when adjusting some of the configuration parameters:

- Use ↑ and ↓ arrows to select parameter (line) to be adjusted.
- Use ← and → arrows to change the value of the selected parameter. If there are two or more sub-parameters in one line (e.g. date and time) then use the **SELECT** key to skip to the next sub-parameters and back.

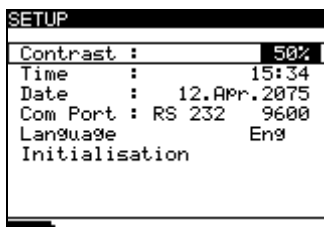

Fig. 5b. Setup menu

Parameter	Value	Note
Contrast	0%..100%	Adjustment of the LCD contrast
Time		Set real time (hour: minute)
Date		Set current date (day-month-year)
Com Port	RS 232 2400, RS 232 4800, RS 232 9600, RS 232 19200, USB 115000	Set communication mode and rate.
Language		Set language
Initialization		For internal factory and service maintenance only!

Table 1b. Parameters in Setup menu

5 Measurements

5.1 General Information about High DC voltage testing

The purpose of insulation tests

Insulating materials are important parts of almost every electrical product. The material's properties depend not only on its compound characteristics but also on temperature, pollution, moisture, ageing, electrical and mechanical stress, etc. Safety and operational reliability require the regular maintenance and testing of the insulation material to ensure it is kept in good operational condition. High voltage tests are used to test insulating materials.

DC vs. AC testing voltage

Testing with a DC voltage is widely accepted as being as useful as testing with AC and / or pulsed voltages. DC voltages can be used for breakdown tests especially where high capacitive leakage currents interfere with measurements using AC or pulsed voltages. DC is mostly used for insulation resistance measurement tests. In this type of test, the voltage is defined by the appropriate product application group. This test voltage is lower than the voltage used in the withstanding voltage test so the tests can be applied more frequently without stressing the test material

Typical insulation tests

In general, insulation resistance tests consist of the following possible procedures:

- Simple insulation resistance measurement also called a spot test;
- Measurement of the relationship between voltage and insulation resistance;
- Measurement of the relationship between time and insulation resistance;
- Test of residual charge after the dielectric discharge.

The results of this test can indicate whether the replacement of the insulation system is needed.

Typical examples of where testing insulation resistance and its diagnosis are recommended are transformer and motor insulation systems, cables and other electrical equipment.

Electrical representation of insulating material

Fig. 7 represents the equivalent electrical circuit of an insulating material

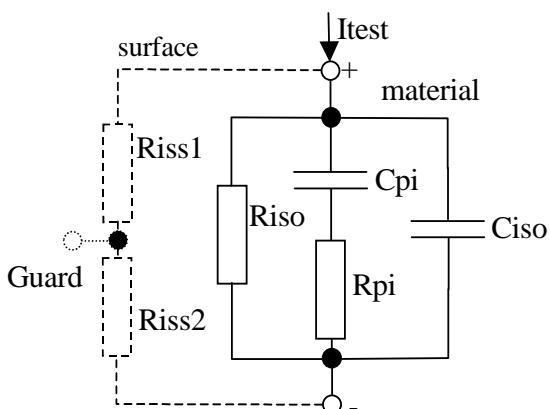

Fig. 7.

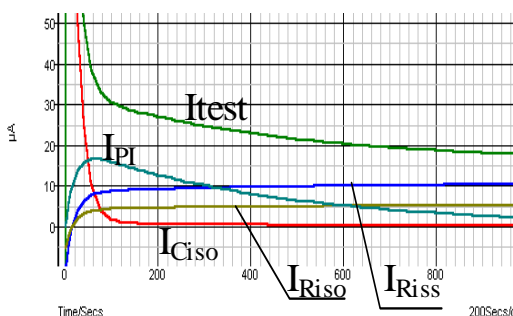

Fig. 8.

R_{iss1} and R_{iss2} - the surface resistivity (position of optional guard connection)

R_{iso} – the actual insulation resistance of material

C_{iso} – capacitance of material

C_{pi} , R_{pi} - represents polarization effects.

Fig. 8 shows typical currents for that circuit.

I_{test} = overall test current ($I_{test} = I_{PI} + I_{RISO} + I_{RISS}$)

I_{PI} = polarization absorption current

I_{RISO} = actual insulation current

I_{RISS} = surface leakage current

Some application examples for using Teraohm 5 kV

Basic Insulation resistance test

Virtually every standard concerning the safety of electrical equipment and installations requires the performance of a basic insulation testing. When testing lower values (in the range of $M\Omega$), the basic insulation resistance (R_{iso}) usually dominates. The results are adequate and stabilize quickly.

It is important to remember the following:

- The voltage, time and limit are usually given in the appropriate standard or regulation.
- Measuring time should be set to 60 s or the minimum time required for the Insulation capacitance (C_{iso}) to be charged up.
- Sometimes it is required to take ambient temperature into account and adjust the result for a standard temperature of $40^{\circ}C$.
- If surface leakage currents interfere with the measurements (see R_{iss} above) use the guard connection (see 5.2.). This becomes critical when measured values are in the $G\Omega$ range.

Voltage dependence test – Step voltage test

This test shows if the insulation under test has been electrically or mechanically stressed. In this instance the quantity and size of insulation anomalies (e.g. cracks, local breakdowns, conductive parts, etc.) is increased and the overall breakdown voltage is reduced. Excessive humidity and pollution have an important role especially in the case of mechanical stress.

- The test voltage steps are usually close to those required in the DC withstanding test.
- Sometimes it is recommended that the maximum voltage for this test should not be higher than 60 % of the withstanding voltage.

If the results of successive tests show a reduction in the tested insulation resistance the insulation should be replaced.

Time dependence test – Diagnostic test

POLARISATION INDEX

The purpose of this diagnostic test is to evaluate the influence of the polarization part of insulation (R_{pi} , C_{pi}).

After applying a high voltage to an insulator the electric dipoles distributed in the insulator align themselves with the applied electrical field. This phenomenon is called polarization. As the molecules polarize, a polarization (absorption) current lowers the overall insulation resistance of the material.

The absorption current (I_{PI}) typically collapses after a few minutes. If the overall resistance of the material doesn't increase, this means that other currents (e.g. surface leakages) dominate the overall insulation resistance.

- PI is defined as the ratio of the measured resistances in two time slots. The most typical ratio is 10 min value to 1 min value but this is not a rule.
- The test is typically performed at the same voltage as the insulation resistance test.
- If the one-minute insulation resistance is greater than 5000 MΩ, then this measurement may not be valid (new modern types of insulation).
- Oiled paper used in transformers or motors is a typical insulation material that requires this test.

In general, insulators that are in good condition will show a "high" polarization index while insulators that are damaged will not. Note that this rule is not always valid. Refer to Metrel's handbook **Insulation Testing Techniques** for more information.

General applicable values:

PI value	Tested material status
1 to 1.5	Not acceptable (older types)
2 to 4 (typically 3)	Considered as good insulation (older types)
4 (very high insulation resistance)	Modern type of (good) insulation systems

Example for minimum acceptable values for motor insulation (IEEE 43):

Class A =1.5, Class B = 2.0, Class F =2.0, Class H =2.0.

DIELECTRIC DISCHARGE

The polarisation effect (described in "Polarisation Index") causes a capacitance to form (C_{pi}). Ideally this charge would dissipate immediately a voltage was removed from the material. In practice, this is not the case.

In conjunction with the polarisation index (PI), Dielectric Discharge (DD) is another way to check the quality and suitability of a insulation material. A material that discharges quickly would provide a low value while a material that takes a long time to discharge will provide a higher value (described in the table below, for more information see section 5.6).

DD value	Tested material status
> 4	bad
2 - 4	critical
< 2	good

Withstanding voltage test

Some standards allow the use of a DC voltage as an alternative to AC withstanding voltage testing. For this purpose the test voltage has to be present across the insulation under test for a specific time. The insulation material only passes if there is no breakdown or flash over. Standards recommend that the test starts with a low voltage

and reaches the final test voltage with a slope that keeps the charging current under the limit of the current threshold. The test duration normally takes 1 min.

Withstanding voltage test or dielectric test is usually applied for:

- Type (acceptance) tests when a new product is being prepared for manufacture,
- Routine (production) tests for the verification of safety on each product,
- Maintenance and after service tests for any equipment where insulation system can be exposed to degradation.

Some examples for DC withstanding test voltage values:

Standard (only sample values)	Voltage
EN/IEC 61010-1 CAT II 300 V basic insulation	1970 V
EN/IEC 61010-1 CAT II 300 V double insulation	3150 V
IEC 60439-1 (clearance between live parts...), withstanding impulse voltage 4 kV, 500 m	4700 V
IEC 60598-1	2120 V

Humidity and insulation resistance measurements

When testing outside the reference ambient conditions, the quality of the insulation resistance measurements can be affected by humidity. Humidity adds leakage paths onto the surface of the complete measuring system, (i.e. the insulator under test, the test leads, the measuring instrument etc). The influence of humidity reduces accuracy especially when testing very high resistances (i.e. tera ohms). The worst conditions arise in environments containing high condensation, which can also reduce safety. In the case of high humidity, it is recommended to ventilate the test areas before and during the measurements. In the case of condensed humidity the measuring system must dry and it can take several hours or even few days to recover.

5.2 Guard terminal

The purpose of the GUARD terminal is to lead away potential leakage currents (e.g. surface currents), which are not a result of the measured insulation material itself but are a result of surface contamination and moisture. This current interferes with the measurement i.e. the Insulation Resistance result is influenced by this current. The GUARD terminal is internally connected to the same potential as the negative test terminal (black one). The GUARDs test clip should be connected to the test object so as to collect most of the unwanted leakage current, see the **Fig. 9** below.

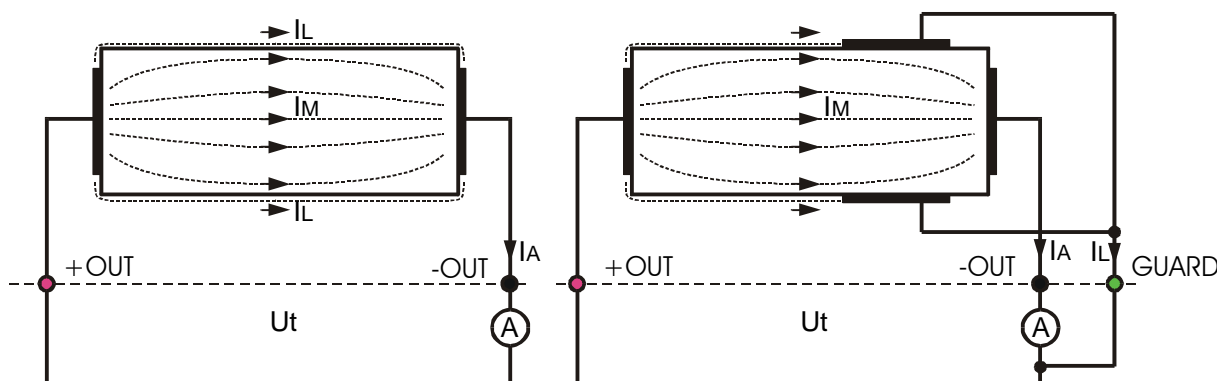

Fig. 9. Connection of GUARD terminal to measured object

Where:

Ut..... Test voltage

IL..... Leakage current (resulted by surface dirt and moisture)

IM..... Material current (resulted by material conditions)

IA..... A-meter current

Result without using GUARD terminal: $R_{INS} = U_t / I_A = U_t / (I_M + I_L)$...incorrect result.

Result using GUARD terminal: $R_{INS} = U_t / I_A = U_t / I_M$ correct result.

It is recommended to use the GUARD connection when high insulation resistance (>10G Ω) are measured.

Note:

- The guard terminal is protected by an internal impedance (200 K Ω).
- The instrument has two guard terminals to allow easy connection of shielded measuring leads.

5.3 Filter options

Filters are built in to reduce the influence of noise on measurement results. This option enables more stable results especially when dealing with high Insulation Resistances (Insulation Resistance, Diagnostic Test, Step Voltage). In these functions, the status of the filter option is shown in the top right corner of the LCD screen. The table below contains a definition of the individual filter options:

Fil0	Low pass filter with cut off frequency of 0.5 Hz in signal line.
Fil1	Additional low pass filter with cut off frequency of 0.05 Hz in the signal line.
Fil2	Fil1 with increased integrating time (4 s).
Fil3	Fil2 with additional cyclic averaging of 5 results.

Table 2. Filter options

THE PURPOSE OF FILTERING

In simple terms the filters smooth the measured currents by means of averaging and bandwidth reduction. There are various sources of disturbance:

- AC currents at the mains frequency and its harmonics, switching transients etc, cause the results to become unstable. These currents are mostly cross talk through insulation capacitances close to live systems,
- Other currents induced or coupled in the electromagnetic environment of the insulation under test.
- Ripple current from internal high voltage regulator,
- Charging effects of high capacitive loads and / or long cables.

Voltage changes are relatively narrow on high resistance insulation, so the most important point is to filter the measured current.

Note:

Any of the selected filter options increases the settling time with Fil1 to 60 s, Fil2 to 70 s, and Fil3 to 120 s.

- It is necessary to pay close attention to the selection of time intervals when using the filters.
- The recommended minimum measuring times when using filters are the settling times of the selected filter option.

Example:

A noise current of 1 mA / 50 Hz adds approximately $\pm 15\%$ distribution to the measured result when measuring 1 G Ω .

By selecting FIL1 option the distribution will reduce to less than $\pm 2\%$.

In general using FIL2 and FIL3 will further improve the noise reduction.

5.4 Voltage measurement

Selecting this function displays the following states (initial state and state with results after completion of the measurement). See *fig. 10* below.

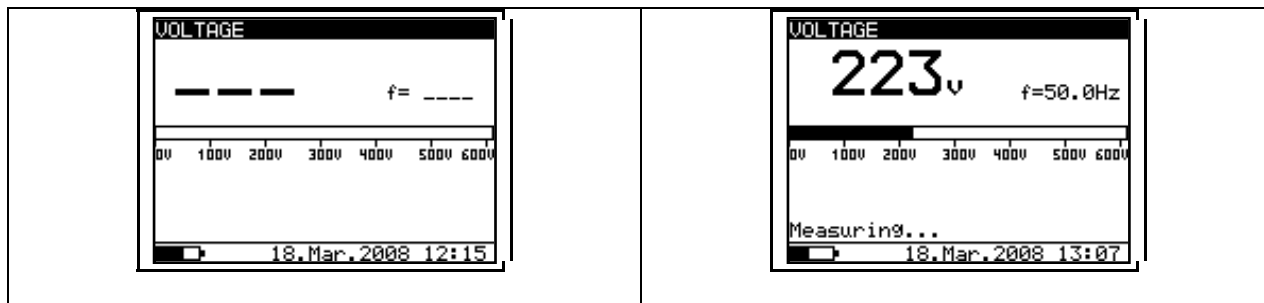

Fig. 10. Voltage function display states

Measurement procedure:

- Connect the test leads to the instrument and to the measured source.
- Press the **START** key to start the measurement, continuous measurement starts to run.
- Press the **START** key again to stop the measurement.
- The result (see the right picture in *Fig 10*) can optionally be saved by pressing the **MEM** key twice, see chapter 6.1. Store, Recall and Clear Operation.

Warning!

- Refer to Warnings chapter for safety precautions!

5.5 Insulation Resistance measurement

Selecting this function displays the following states (initial state and state with results after the completion of the measurement). **Fig 11** shows states when Graph R(t) is disabled.

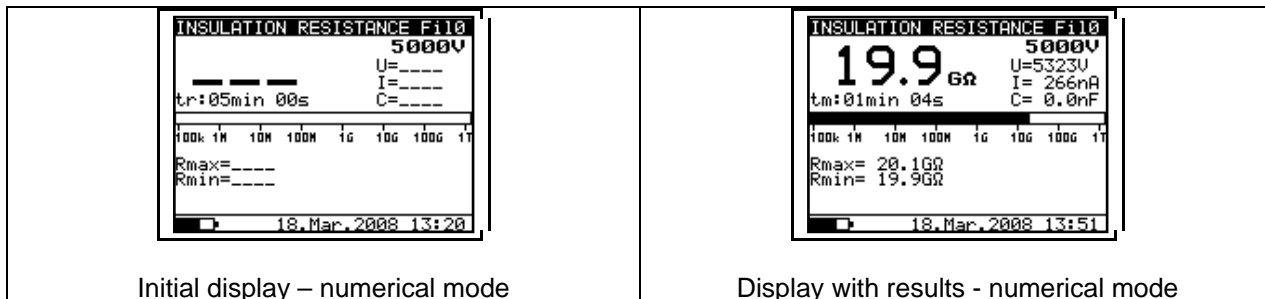

Fig. 11. Insulation Resistance function display states - Graph R(t) disabled

Fig. 12 shows states when Graph R(t) is enabled. When Graph R(t) is enabled you can simple switching initial state and state with results after the completion of the measurement, between numerical and graphical mode with pressing ↑ or ↓ keys.

- ↑ graphical mode
- ↓ numerical mode

Note:

- It is not possible to switching mode of presentation when measurement running!!!

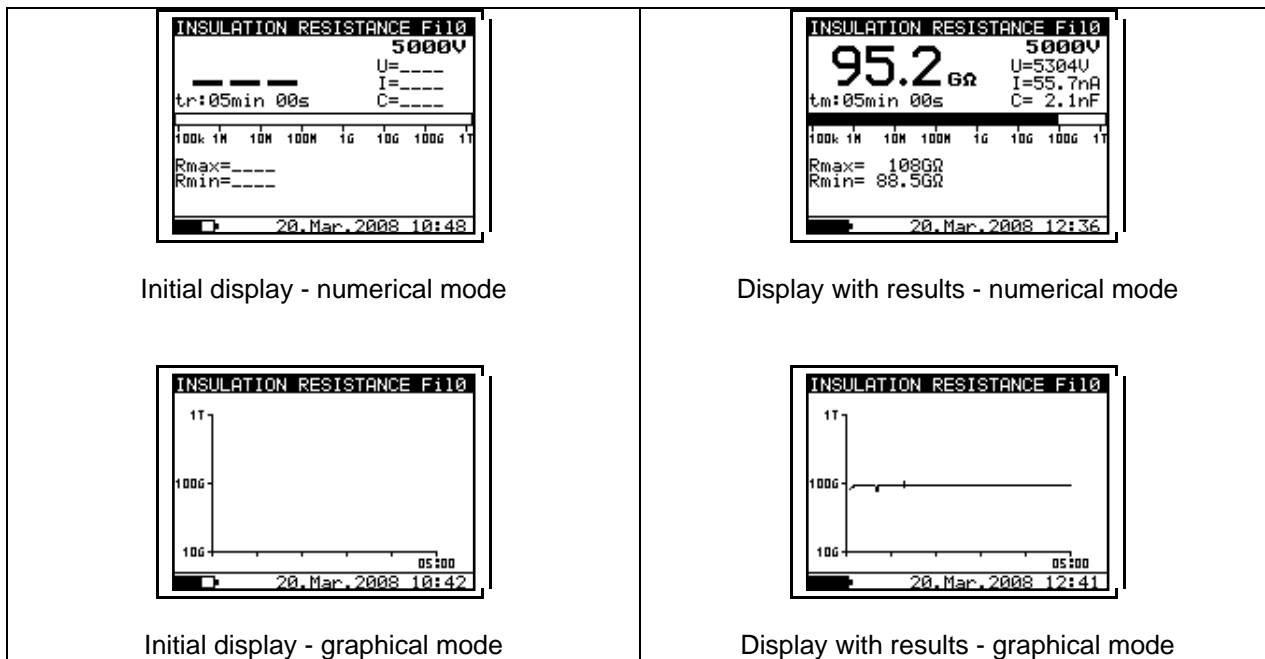

Fig. 12. Insulation Resistance function display states - Graph R(t) enabled

Measurement procedure:

- Connect the test leads to the instrument and to the test object.
- Select **INSULATION RESISTANCE** function in **MAIN MENU**.
- Press the **START/STOP** key and release it, continuous measurement will begin.
- Wait until the test result has stabilized then press the **START/STOP** key again to stop the measurement or, if enabled, wait for the set timer runs out.
- Wait for the object under test to discharge.
- The result can optionally be saved pressing the **MEM** key twice, see chapter 6.1. Store, Recall and Clear Operation.

Legend of displayed symbols:

fil0 (Fil1, Fil2, Fil3)	Filter type enabled, see the chapter 5.3. Configuration
5000V	Set test voltage
U=5323V	Actual test voltage – measured value
I=266nA	Actual test current – measured value
19.9GΩ	Insulation Resistance – result
C=0.0nF	Capacitance of measured object
tm:04min 26s	Timer information – test duration
Bar	Analogue representation of result
Rmax=20.1GΩ	Maximum value of result (only if timer is enabled)
Rmin=19.9GΩ	Minimum value of result (only if timer is enabled)

Notes:

- If the timer is disabled then **OFF** is displayed instead of the timer value.
- During a measurement, the timer information displays the time needed to complete the measurement (tr) while after the completion the test duration (tm) is displayed.
- A high-voltage warning symbol appears on the display during the measurement to warn the operator of a potentially dangerous test voltage.
- Value of capacitance is measured during the final discharge of the test object.

Setting up parameters for Insulation Resistance test:

- Press the **SELECT** key, the set-up menu will appear on the display, see the **Fig 13**.
- Select the parameter (line) to be set using the **↑** and **↓** keys;
- Adjust set parameter using the **←** and **→** keys. Skip to the next sub-parameter by pressing the **SELECT** key (if there are two or more sub-parameters) and repeat the adjustment.
- Complete the set-up adjustments by pressing either the **ESC** key or **START/STOP** key (to run the measurement directly). The settings displayed last are stored.

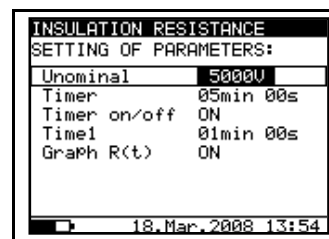

Fig. 13. Set-up menu in Insulation Resistance measurement

Legend of displayed symbols:

INSULATION RESISTANCE		Name of selected function
SETTING PARAMETERS:		
Unominal	5000V	Set test voltage –25 V steps
Timer	5min 00s	Duration of the measurement
Timer on/off	ON	ON: timer enabled, OFF: timer disabled
Time1	01min 00s	Time to accept and display first Rmin and Rmax results
Graph R(t)	ON	Enable/Disable Graph R(t)

Timer and Time1 are independent timers. Maximum time for each of them is 99 min 60 s.

Enable/Disable the graph R(t) and Set-up the graph R(t) parameters in the **Insulation Resistance** function:

- Press the **SELECT** key, Set-up menu appears on display, see the **Fig. 14**.
- Select the parameter **Graph R(t)** to be set using the **↑** and **↓** keys;
- **Enable/Disable** the **graph R(t)** using the **←** and **→** keys.
- Press the **SELECT** key to Set-up the parameters of the **graph R(t)**, see the **Fig. 15**. Press the **ESC** key to return to basic Set-up menu in the **Insulation Resistance** function.
- Complete the set-up adjustments pressing either the **ESC** key or **START/STOP** key (to run the measurement directly). The last displayed settings are stored.

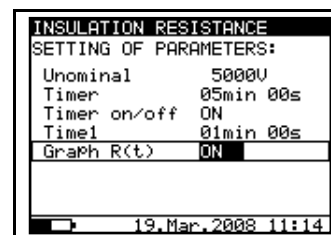

Fig. 14. Set-up menu in Insulation Resistance measurement

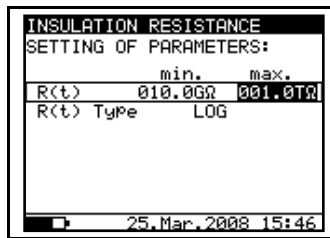

Fig. 15. Set-up menu of the Graph R(t)

Notes:

- If the Timer is OFF is not possible to Enable the Graph R(t).
- The time duration of Graph R(t) is equal to the value of Timer.
- The Timer value could be very long (up to 100 minutes), so the Special automatic decimation algorithm is use to write the Graph R(t) to the LCD.
- The cursors of the Graph R(t) could be activated with ← key
- The cursors of the Graph R(t) could be moved with ← and → keys.

Warning!

- Refer to Warnings chapter for safety precautions!

5.6 Diagnostic Test

Selecting this function displays the following states (initial state and state with results after the completion of the measurement). **Fig. 16** shows states when Graph R(t) is disabled.

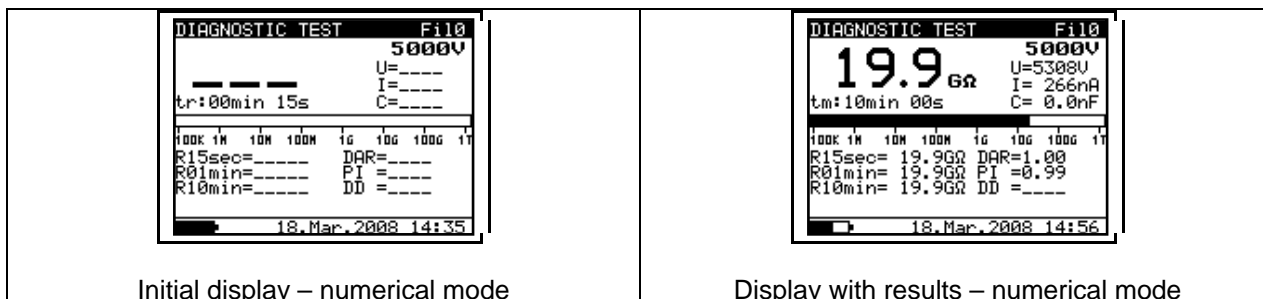

Fig. 16. Diagnostic test display states - Graph R(t) disabled

Fig. 17 shows states when Graph R(t) is enabled. When Graph R(t) is enabled you can simple switching initial state and state with results after the completion of the measurement, between numerical and graphical mode with pressing ↑ or ↓ keys.

- ↑ graphical mode
- ↓ numerical mode

Note:

- It is not possible to switching mode of presentation when measurement running!!!

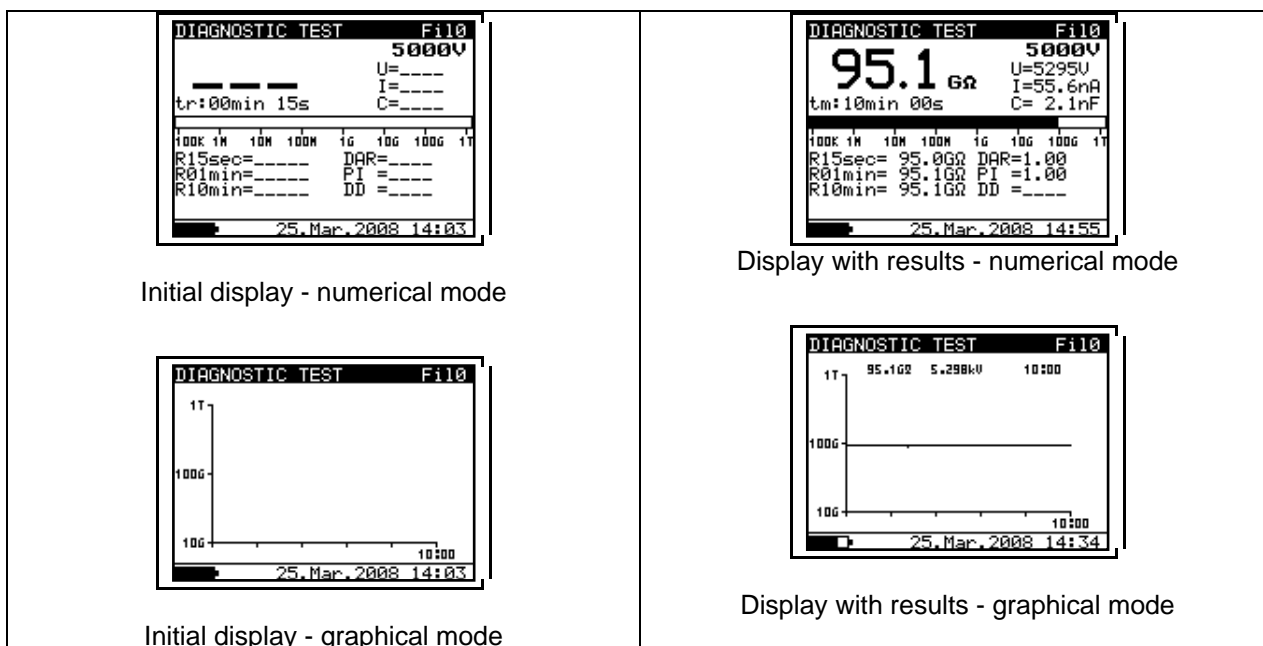

Fig. 17. Diagnostic test display states - Graph R(t) enabled

Diagnostic test is a long duration test for evaluating the quality of the insulation material under test. The results of this test enable the decision to be made on the preventive replacement of the insulation material.

DIELECTRIC ABSORPTION RATIO (DAR)

DAR is ratio of Insulation Resistance values measured after 15s and after 1 minute. The DC test voltage is present during the whole period of the test (also an Insulation Resistance measurement is continually running). At the end, the DAR ratio is displayed:

$$DAR = \frac{R_{iso}(1\text{min})}{R_{iso}(15\text{s})}$$

Some applicable values:

DAR value	Tested material status
< 1.25	Not acceptable
< 1.6	Considered as good insulation
> 1.6	Excellent

Note: When determining R_{iso} (15s) pay attention to the capacitance of test object. It has to be charged-up in the first time section (15s). Approximate maximum capacitance using:

$$C_{\max} [\mu F] = \frac{t [s] 10^3}{U [V]}$$

Where:

t..... period of first time unit (e.g. 15s)

U test voltage.

To avoid this problem, increase the **DIAG. Starting time** parameter in CONFIGURATION menu, because the start of timer in the DIAGNOSTIC TEST functions depends on the test voltage. The Timer begins to run when test voltage reaches the threshold voltage, which is product of the **DIAG. Starting time** and nominal test voltage **Unominal**.

Using filters (fil1,fil2,fil3) in the DAR function is not recommended!

Analysing the change in the measured insulation resistance over time and calculating the DAR and PI are very useful maintenance tests of an insulating material.

POLARIZATION INDEX (PI)

PI is the ratio of Insulation Resistance values measured after 1 minute and after 10 minutes. The DC test voltage is present during the whole period of the measurement (an Insulation Resistance measurement is also running). On completion of the test the PI ratio is displayed:

$$PI = \frac{R_{iso} (10 \text{ min})}{R_{iso} (1 \text{ min})}$$

Note: When determining Riso (1min) pay close attention to the capacitance of the object under test. It has to be charged-up in the first time section (1 min). Approximate maximum capacitance using:

$$C_{\max} [\mu F] = \frac{t [s] 10^3}{U [V]}$$

where:

t..... period of first time unit (e.g. 1min)

U test voltage.

To avoid this problem, increase the **DIAG. Starting time** parameter in CONFIGURATION menu, because the start of timer in the DIAGNOSTIC TEST functions depends on the test voltage. The timer begins to run when test voltage reaches the threshold voltage, which is product of the **DIAG. Starting time** and nominal test voltage (**Unominal**).

Analysing the change in the measured insulation resistance over time and calculating the DAR and PI are very useful maintenance tests of an insulating material.

DIELECTRIC DISCHARGE TESTING (DD)

DD is the diagnostic insulation test carried out after the completion of the Insulation Resistance measurement. Typically the insulation material is left connected to the test voltage for 10 ÷ 30 min and then discharged before the DD test is carried out. After 1 minute a discharge current is measured to detect the charge re-absorption of the insulation material. A high re-absorption current indicates contaminated insulation (mainly based on moisture):

$$DD = \frac{I_{dis1 \text{ min}} [mA]}{U [V] \cdot C [F]}$$

where:

I_{dis 1 min}discharging current measured 1 min after regular discharge

Utest voltage

Ccapacitance of test object.

Measurement procedure:

- Select **DIAGNOSTIC TEST** function in **MAIN MENU**.
- Connect the test leads to the instrument and to the measured object.
- Press the **START/STOP** key to start the measurement.
- Wait until set timer runs out, the result is displayed.
- Wait until the object under test has discharged
- The result can optionally be saved by pressing the **MEM** key twice, see the chapter 6.1. Store, Recall and Clear Operation.

Legend of displayed symbols:

Fi10 (Fi11, Fi12, Fi13)	Filter type enabled, see the chapter 5.3. Configuration
5000V	Set test voltage – step 25 V
U=5295	Actual test voltage – measured value
I=55.6nA	Actual test current – measured value
10.5GΩ	Insulation Resistance – result
C=2.1nf	Capacitance of measured object
Tr:00min 15s	Set timer value
Bar	Analogue representation of Riso result
R15sec=10.6GΩ	Resistance value measured after set time 1
R01min=10.5GΩ	Resistance value measured after set time 2
R10min=10.5GΩ	Resistance value measured after set time 3
DAR=1.67	DAR as ratio of R1min / R15s
PI=1.21	PI as ratio of R03/R02
DD=___	DD result

Notes:

- A high-voltage warning symbol appears on the display during the measurement to warn the operator of a potentially dangerous test voltage.
- The value of the capacitance is measured during the final discharge of the test object.
- If enabled, the instrument measures Dielectric Discharge (DD) when the capacitance is in the range of 5 nF to 50 μF.

Setting-up parameters of the Diagnostic Test:

- Press the **SELECT** key, (the Set-up menu appears on display, see the **Fig. 18**).
- Select the parameter to be set using the **↑** and **↓** keys;
- Adjust the parameter using the **←** and **→** keys.
- Complete the set-up adjustments by pressing either the **ESC** key or **START** key (to run the measurement directly). The settings displayed last are stored.

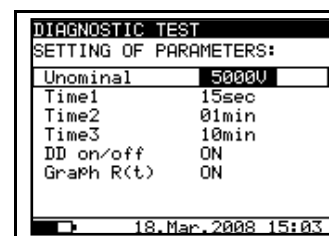

Fig. 18. Set-up menu in Diagnostic Test

Legend of displayed symbols:

DIAGNOSTIC TEST		Name of selected function
SETTING PARAMETERS:		
Unominal	5000V	Set test voltage – step 25 V
Time1	01min	Time node to take R1min result
Time2	02min	Time node to take R2min result and calculate DAR
Time3	03min	Time node to take R3min result and calculate PI
DD on/off	ON	ON: DD enabled, OFF: DD disabled
Graph R(t)	ON	Enable/Disable Graph R(t)

Time1, Time2 and Time3 are timers with the same start point. The value of each presents the duration from the start of the measurement. The maximum time is 100 min. The following **Fig. 19** shows the timer relationships.

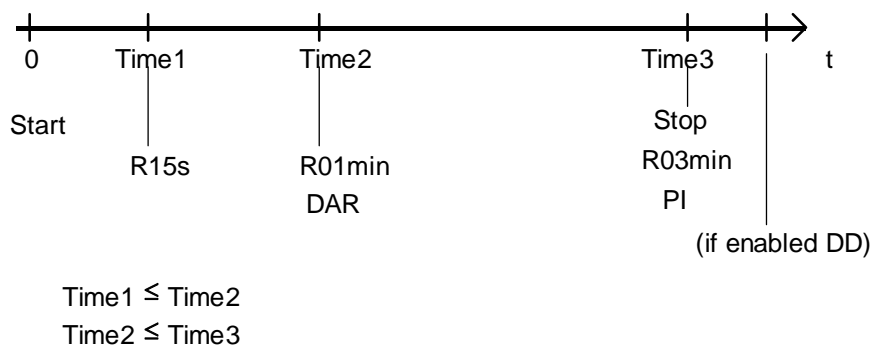

Fig. 19. Timer relations

Enable/Disable the graph R(t) and Set-up the graph R(t) parameters in the Diagnostic Test function:

- Press the **SELECT** key, Set-up menu appears on display, see the **Fig. 20**.
- Select the parameter **Graph R(t)** to be set using the **↑** and **↓** keys;
- **Enable/Disable** the **graph R(t)** using the **←** and **→** keys.
- Press the **SELECT** key to Set-up the parameters of the **graph R(t)**, see the **Fig. 21**. Press the **ESC** key to return to basic Set-up menu in the **Diagnostic Test** function.
- Complete the set-up adjustments pressing either the **ESC** key or **START/STOP** key (to run the measurement directly). The last displayed settings are stored.

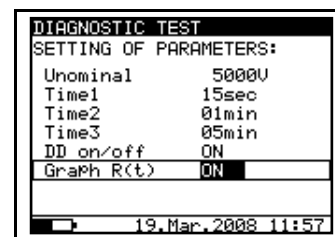

Fig. 20. Set-up menu in Diagnostic Test measurement

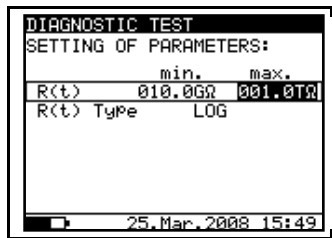

Fig. 21. Set-up menu of the Graph R(t)

Notes:

- The time duration of Graph R(t) is equal to the value of Timer 3.
- The Timer value could be very long (up to 100 minutes), so the Special automatic decimation algorithm is use to write the Graph R(t) to the LCD.
- The cursors of the Graph R(t) could be activated with ← key
- The cursors of the Graph R(t) could be moved with ← and → keys.

Warning!

- Refer to Warnings chapter for safety precautions!

5.7 Step Voltage Insulation Resistance testing

Selecting this function displays the following states (initial state and state with results after the completion of the measurement). **Fig. 22** shows states when Graph R(t) is disabled.

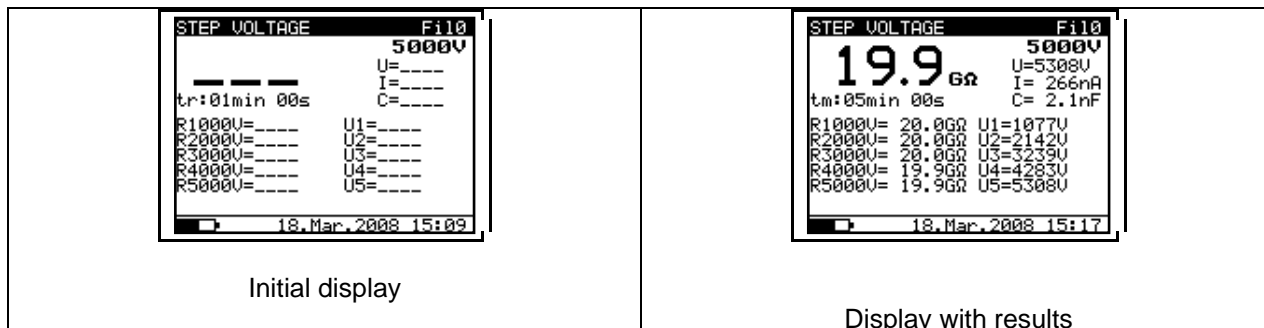

Fig. 22. Step Voltage function display states- Graph R(t) disabled

Fig. 23 shows states when Graph R(t) is enabled. When Graph R(t) is enabled you can simple switching initial state and state with results after the completion of the measurement, between numerical and graphical mode with pressing ↑ or ↓ keys.

- ↑ graphical mode
- ↓ numerical mode

Note:

- It is not possible to switching mode of presentation when measurement running!!!

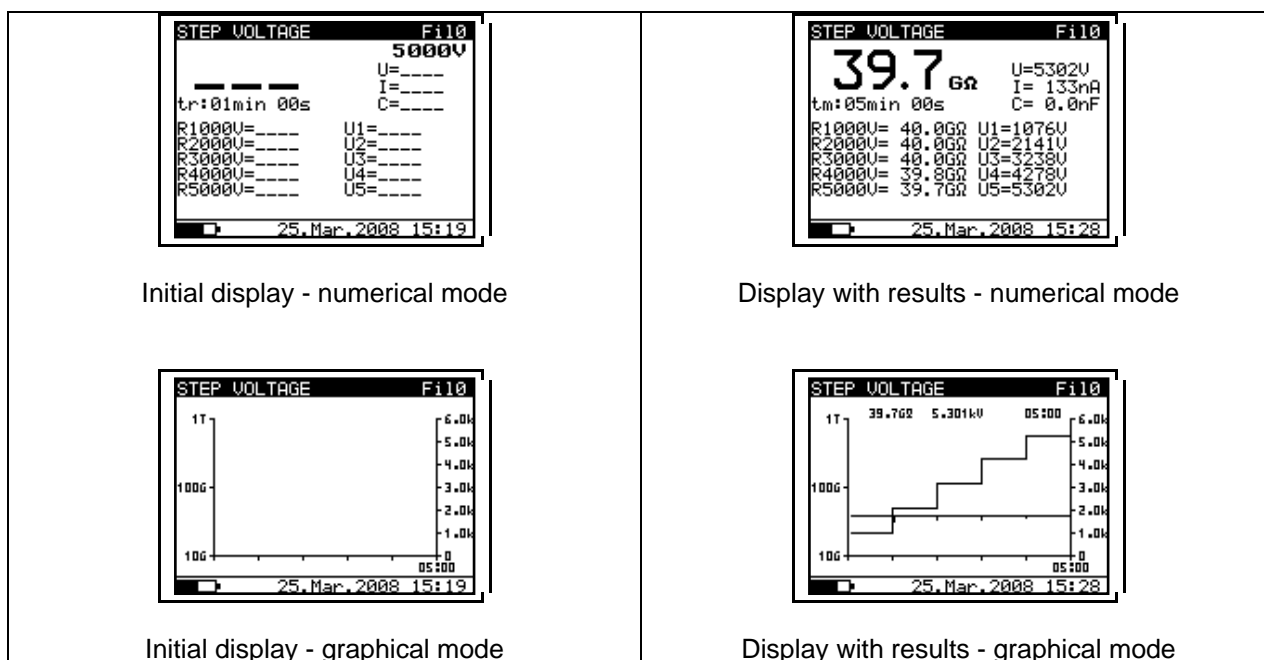

Fig. 23. Step Voltage function display states - Graph R(t) enabled

In this test, the insulation is measured in five equal time periods with test voltages from one fifth of the final test voltage up to full scale (see the **Fig. 24**). This function illustrates the relationship of a materials Insulation resistance and its applied voltage

Measurement procedure:

- Connect the test leads to the instrument and to the test object.
- Press the **START/STOP** key to start the measurement.
- Wait until set timer runs out, (the result will be displayed).
- Wait for the object under test to discharge
- The results can be saved by pressing the **MEM** key twice, see the chapter 6.1. Storing, Recalling and Clearing Results.

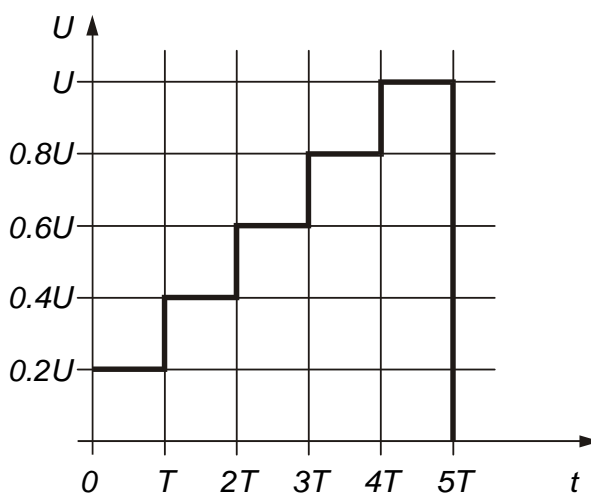

Fig. 24. Step-up test voltage

Legend of displayed symbols:

Fi10 (Fi11, Fi12, Fi13)	Filter type enabled, see the chapter 5.3. Configuration
5000V	Set test voltage – step 125 V
U=5308V	Actual test voltage – measured value
I=266nA	Actual test current – measured value
19.9GΩ	Insulation Resistance – result
C=1.2nF	Capacitance of measured object
Tm:05min 00s	Actual test duration
R1000V=20.0GΩ	Last result of 1 st step
R2000V=20.0GΩ	Last result of 2 nd step
R3000V=20.0GΩ	Last result of 3 rd step
R4000V=19.9GΩ	Last result of 4 th step
R5000V=19.9GΩ	Last result of 5 th step
U1=1077V	1 st step voltage
U2=2142V	2 nd step voltage
U3=3239V	3 rd step voltage
U4=4283V	4 th step voltage
U5=5308V	5 th step voltage

Notes:

- Timer information is displayed from the start of the measurement until the completion of each step measurement.
- Timer information shows the complete measurement period after the completion of the measurement.
- A high-voltage warning symbol appears on the display during the measurement to warn the operator of a potentially dangerous test voltage.
- The value of capacitance is measured during the final discharge of test object.

Setting up parameters for the Step Voltage test:

- Press the **SELECT** key, (the Set-up menu (**Fig. 25**) will appear on the display).
- Select the parameter (line) to be set using the \uparrow and \downarrow keys;
- Adjust the parameter using the \leftarrow and \rightarrow keys.

Complete the parameter adjustments by pressing either the **ESC** or the **START/STOP** key (to run the measurement directly). The settings displayed last will be saved

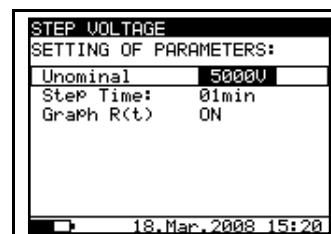

Fig. 25. Set-up menu in Step Voltage Test

Legend of displayed symbols:

STEP VOLTAGE		Name of selected function
SETTING PARAMETERS:		
Unominal	5000V	Set test voltage – step 125 V
Step Time	01min	Duration of measurement per step
Graph R(t)	ON	Enable/Disable Graph R(t)

Note:

- Maximum value for Step Time is 30 min.

Enable/Disable the graph R(t) and Set-up the graph R(t) parameters in the Step Voltage function:

- Press the **SELECT** key, Set-up menu appears on display, see the **Fig. 26**.
- Select the parameter **Graph R(t)** to be set using the \uparrow and \downarrow keys;
- **Enable/Disable** the **graph R(t)** using the \leftarrow and \rightarrow keys.
- Press the **SELECT** key to Set-up the parameters of the **graph R(t)**, see the **Fig. 27**. Press the **ESC** key to return to basic Set-up menu in the **Step Voltage** function.
- Complete the set-up adjustments pressing either the **ESC** key or **START/STOP** key (to run the measurement directly). The last displayed settings are stored.

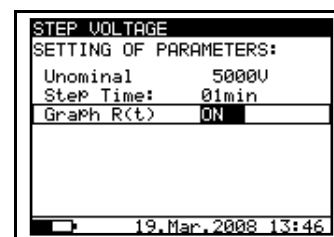

Fig. 26. Set-up menu in Step Voltage measurement

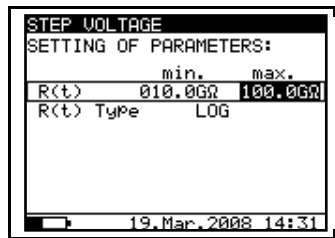

Fig. 27. Set-up menu of the Graph R(t)

Notes:

- The time duration of Graph R(t) is equal to the value of Step Time Multiplied by 5.
- The Timer value could be very long (up to 150 minutes), so the Special automatic decimation algorithm is use to write the Graph R(t) to the LCD.
- The cursors of the Graph R(t) could be activated with ← key
- The cursors of the Graph R(t) could be moved with ← and → keys.

Warning!

- Refer to Warnings chapter for safety precautions!

5.8 Withstanding voltage

This function offers Withstanding Voltage test of insulation material. It covers two types of tests:

- a) Breakdown voltage testing of high voltage device, e.g. transient suppressors
- b) DC withstanding voltage test for insulation coordination purposes.

Both functions require breakdown current detection. In the function, the test voltage is increased from the starting voltage to the stop voltage over a predefined time (set by the parameters). The Stop voltage is then maintained for a predefined test time, (see the **Fig. 28**).

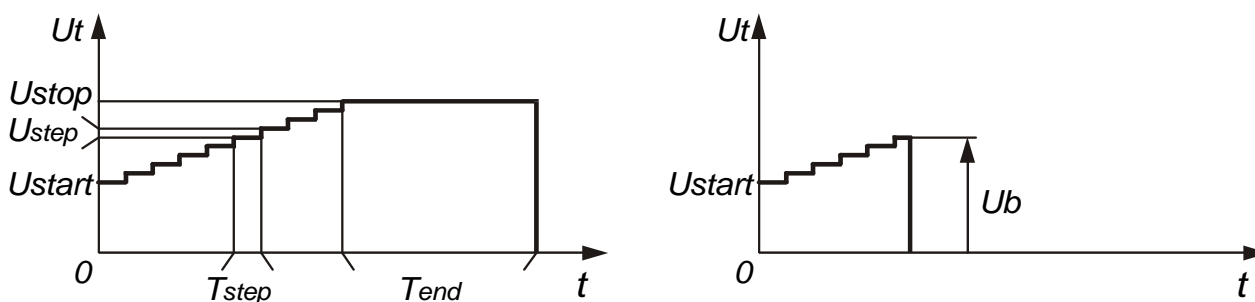

Fig. 28. Test voltage presentation without breakdown (left part) and with breakdown (right part)

- Ut..... Test voltage
- Ustop .. End test voltage
- Ustep .. Voltage step approx. 25 V (fixed value - not presetable)
- Ustart.. Starting voltage
- Tstep... Test voltage duration per step
- Tend ... Constant test voltage duration after reaching End value
- t..... Time
- Ub Breakdown voltage

Selecting this function displays the following states. **Fig. 29** shows the initial screen and a screen with results after the completion of a measurement

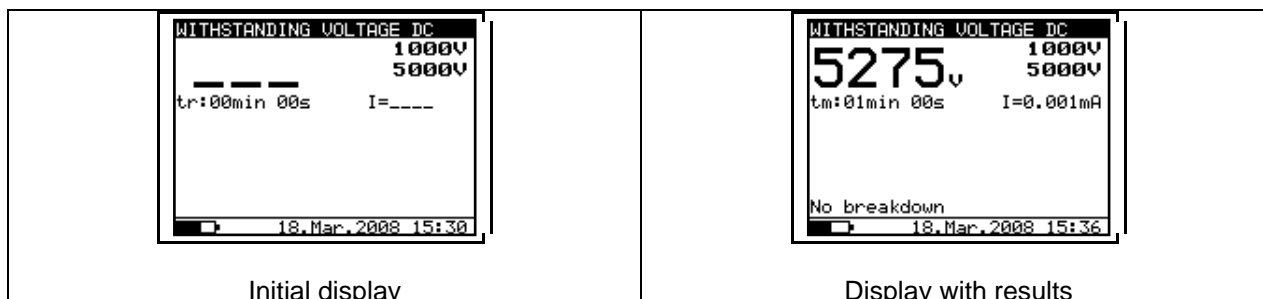

Fig. 29. Withstanding Voltage function display states

Legend of displayed symbols:

WITHSTANDING VOLTAGE DC	Name of selected function
1000V	Start test voltage
5000V	Stop test voltage
5275V	Actual test voltage – measured value
I=0.001mA	Actual test current – measured value
tm:01min 00s	Timer information

Measuring procedure:

- Connect the test leads to the instrument and to the measured object.
- Press the **START/STOP** key to start the measurement.
- Wait until the set timers runs out or until breakdown occurs, (the result will be displayed).
- Wait for the object under test is discharge.
- The results can be saved by pressing the **MEM** key twice, see the chapter 6.1. Storing, Recalling and Clearing Results.

Note:

- Breakdown is detected when the measured current reaches or exceeds the set current level I_{trig} .

Notes:

- The timer shows the time needed to complete each step during the measurement and it shows the total measurement period after the completion of the measurement.
- A high-voltage warning symbol appears on the display during the measurement to warn the operator of a potentially dangerous test voltage.

Legend of displayed symbols:

WITHSTANDING VOLTAGE DC	Name of selected function
SETTING PARAMETERS:	
Ustart	1000V Start test voltage, step = 25 V
Ustop	5000V Stop test voltage, step = 25 V
Tstep	00min 00s Duration of test voltage per one step
Tend	01min 00s Duration of constant test voltage after reaching stop value
Itrigg	1.000mA Set trigger leakage current, step = 10 μ A

Set-up parameters for Withstanding Voltage:

- Press the **SELECT** key, (the set-up menu (**Fig. 30**) appears on display);
- Select the parameter (line) to be set using the ↑ and ↓ keys;
- Adjust the parameter using the ← and → keys or skip to the next sub-parameter by pressing the **SELECT** key (if there are two or more sub-parameters) and repeat the adjustment.
- Complete the parameter adjustments by pressing either the **ESC** or the **START/STOP** key (to run the measurement directly). The settings displayed last will be saved.

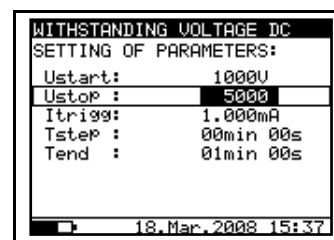

Fig. 30. Set-up menu in Withstanding Voltage function

Notes:

Tstep and Tend are independent timers. The maximum time for each timer is 30 min 60 s. Tend begins after the completion of the ramp period. Ramp period can be calculated from:

$$\text{Tramp} \approx \text{Tstep} \cdot (\text{Ustop} - \text{Ustart}) / 25 \text{ V}$$

If Tstep is set to 00min 00s, then the ramp voltage increases by approximately 25 V every 2s.

Warning!

- Refer to Warnings chapter for safety precautions!

6 Working with your Results

6.1 Storing, Recalling and Clearing Results

The instrument contains battery supported storage memory to retain results when power is disconnected. This enables the test engineer to make the measurements and then to recall them later on. This way the engineer can analyze and print results on the instrument or transfer them to a computer for further analysis.

After pressing the **MEM** key, the memory menu (**Fig. 31**) is displayed. Here the engineer has the option to save, recall and clear results.

SAVE | CLR | RCL | nnnn

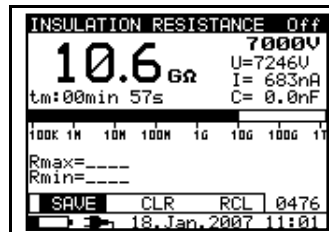

Fig. 31. Storage operation menu

Notes:

nnnn is the results serial number

There are the following possibilities are selectable using the ← or → arrow keys:

- To store result: Highlight **SAVE** and confirm by pressing the **MEM** key. If graph R(t) is enabled in the measurement, it will be automatically saved with the measurement.
- To recall stored result: Highlight **RCL** and confirm by pressing the **MEM** key. The last stored result will be displayed. The menu is replaced with:

Recall measurement without the graph R(t):

Recall: 0006

Recall measurement with the graph R(t):

Recall: 0007 G

“0006” and “0007” represents the serial number of the stored results. G letter means the graph R(t), if added. Results can be scrolled through by using the ↑ and ↓ keys. To see the Graph R(t) press the **SELECT** key, to go back to the numerical measurement result press the **ESC** key.

The recall function can be exited by pressing the **ESC** or **Start** key.

- To clear the last stored result: highlight **CLR** and confirm by pressing the **MEM** key.

To clear the complete memory see paragraph 4.2. Configuration.

In addition to the main result, the subresults and parameters of the selected function are also recorded. The following is a list of all the data stored for each function.

Function	List of stored data
Voltage	Function name Measured voltage Frequency of the measured voltage Ser. number of stored result Date * Time *
Insulation resistance	Function name Measured insulation resistance value Set test voltage Actual test voltage - measured value Actual test current - measured value Capacitance of the tested object Duration of the measurement Maximum detected value of measured resistance Maximum detected value of measured resistance Ser. number of stored result Date * Time *
Diagnostic test	Function name Last measured insulation resistance Set test voltage Actual test voltage - measured value Actual test current - measured value Capacitance of the tested object Duration of the complete test Insulation Resistance value taken after T1 Insulation Resistance value taken after T2 Insulation Resistance value taken after T3 DAR value PI value DD value Ser. number of stored result Date * Time *
Withstanding voltage DC	Function name Last measured test voltage Set Start voltage Set Stop voltage Set trigger current value Actual test current - measured value Set Step test time Set End time Actual test time (at Stop test voltage) Ser. number of stored result Date * Time *

Step voltage	Function name Last measured insulation resistance Set test voltage Actual test voltage - measured value Actual test current - measured value Capacitance of the tested object Complete duration of the measurement First step measured resistance with its nominal voltage First step actual test voltage - measured value Second step measured resistance with its nominal voltage Second step actual test voltage - measured value Third step measured resistance with its nominal voltage Third step actual test voltage - measured value Fourth step measured resistance with its nominal voltage Fourth step actual test voltage - measured value Last step measured resistance with its nominal voltage Last step actual test voltage - measured value Ser. number of the stored result Date * Time *
---------------------	--

Note:

- *Date and time **of storing** the test result are transferred to PC while date and time **of recalling** are displayed when recalling results.

6.2 Transferring Data to a PC

Stored results can be transferred to a PC. A special communication program **TeraLink-PRO** has the ability to identify the instrument and download the data.

How to transfer the stored data:

Connect the instrument to the COM port of the PC using the communication cable (RS232 or USB).

- Power up both the PC and the instrument.
- In the CONFIGURATION menu of the instrument (chapter 4.2), set the communication mode (RS232 or USB) and Baud Rate appropriately. At the end, leave the CONFIGURATION menu by pressing the ESC button.
- Run the **Teralink-PRO** program on the PC. In the Configuration / Com Port menu, set the Com Port and Baud Rate appropriately. The **Auto Find** function can be used to configure Com port Settings automatically. If **Auto Find** function is not successful first time, try one more time.
- The PC and the instrument should automatically recognize each other.

With the TeraLink program, the following tasks can be performed:

- download data;
- clear instrument data;
- change and download user data;
- prepare a simple report form;
- prepare a file to import in to a spreadsheet program.

The program **Teralink-PRO** is a Windows **2000/XP/VISTA™** based PC software

7 Maintenance

7.1 Inspection

To maintain the operator's safety and to ensure the reliability of the instrument it is advisable to inspect the instrument on a regular basis. Check that the instrument and its accessories are not damaged. If any defect is found please consult your service center, distributor or manufacturer.

7.2 Inserting and charging batteries for the first time

Battery cells are stored in the bottom section of the instrument casing under the battery cover (see **Fig. 32**). When inserting batteries for the first time please note the following:

- ◆ **Disconnect any measurement accessories or mains supply cable connected to the instrument before opening the battery cover to avoid electric shock.**
- ◆ **Remove the battery cover.**
- ◆ **Insert the batteries correctly (see *Fig. 32*), otherwise the test instrument will not operate!**
- ◆ **Replace the battery cover and fixed the cover back in place.**

Connect the instrument to the mains power supply for 14 hours to fully charge batteries. (Typical charging current is 300 mA).

When you charge the batteries for the first time, it normally takes about 3 charge and discharge cycles for the batteries to regain full capacity.

7.3 Replacing and charging batteries

The instrument is designed to be power by rechargeable battery supported by mains supply. The LCD contains an indication of battery condition (lower left section of LCD). When the low-battery indication appears the batteries have to be recharged, connect the instrument to the mains power supply for 14 hours to recharge cells. The typical charging current is 300 mA.

Note:

- The operator does not need to disconnect the instrument from mains supply after the full recharging period. The instrument can be connected permanently.

Fully charged rechargeable batteries can supply the instrument for approx. 4 hours. (Continues testing at 5kV)

If the batteries have been stored for a long time, it normally takes about 3 charge and discharge cycles for the batteries to regain full capacity.

Battery cells are stored in the bottom section of the instrument casing under the battery cover (see **Fig. 32**). In case the batteries become defective please note the following:

- ◆ Turn the power off and disconnect any measurement accessories or mains supply cable connected to the instrument before opening the battery cover to avoid electric shock.
- ◆ Remove the battery cover.
- ◆ All six cells have to be replaced and they have to be of the same type.
- ◆ Insert the batteries correctly (see *Fig. 32*), otherwise the test instrument will not operate and battery may be discharged!
- ◆ Replace the battery cover and fixed the cover back in place.
- ◆ The Instrument will only work when rechargeable batteries are inside the instrument.

Nominal power supply voltage is 7.2 V DC. Use six NiMH cells with C size (dimensions: diameter = 26 mm, height = 46 mm). See the next *Fig. 32* for correct polarity of the batteries.

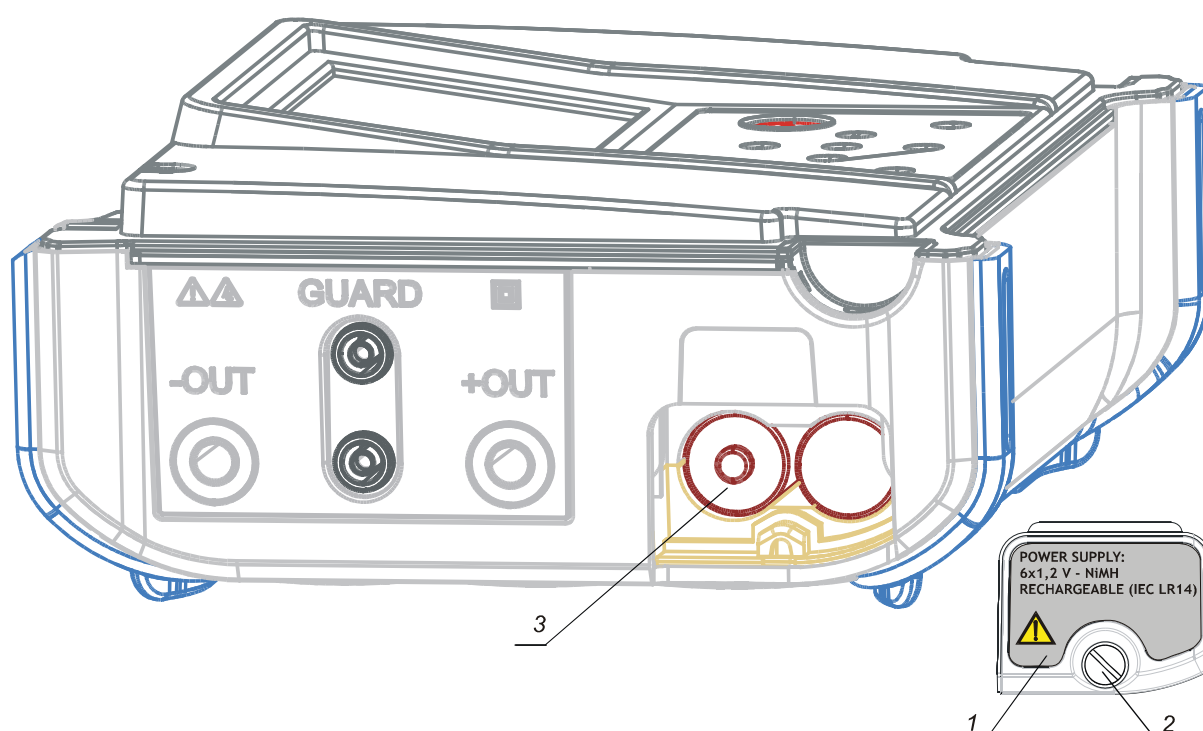

Fig. 32. Correct polarity of inserted batteries

- 1..... Battery cover.
 2..... Screw (unscrew to replace the batteries).
 3..... Correct inserted batteries.

Ensure batteries are used and disposed of in accordance with Manufacturers guidelines and in accordance with Local and National Authority guidelines.



DISCONNECT ALL TEST LEADS AND SWITCH OFF THE INSTRUMENT BEFORE REMOVING THE BATTERY COVER! HAZARDUS VOLTAGE!

7.4 Cleaning

Use a soft cloth, slightly moistened with soapy water or spirit to clean the surface of the instrument and leave the instrument to dry totally before using it.

Notes!

- Do not use liquids based on petrol or hydrocarbons!
- Do not spill cleaning liquid over the instrument!

7.5 Calibration

It is essential that all measurement instruments be regularly calibrated. For occasional daily use we recommend an annual calibration to be carried out. When the instrument is used continuously every day, we recommend calibrating the instrument every six months.

7.6 Service

For repairing under or out of warranty period contact your distributor for further information.

8 Specifications

8.1 Measurement specifications

Note: All data regarding accuracy is given for nominal (reference) environment condition.

Insulation resistance

Nominal test voltage: 250 V to 5 kV, steps by 25V
 Current capability of test generator: >1 mA
 Short-circuit test current: 5 mA \pm 10%
 Automatic discharge of tested object: yes

Measuring range Riso: 0.12 M Ω up to 10 T Ω *)

Display range Riso	Resolution	Accuracy
5 k Ω ÷ 999 k Ω	1 k Ω	\pm (5 % of reading + 3 digits)
1.00 ÷ 9.99 M Ω	10 k Ω	
10.0 ÷ 99.9 M Ω	100 k Ω	
100 ÷ 999 M Ω	1 M Ω	
1.00 ÷ 9.99 G Ω	10 M Ω	
10.0 ÷ 99.9 G Ω	100 M Ω	
100 ÷ 999 G Ω	1 G Ω	\pm (15 % of reading + 3 digits)
1.00 ÷ 10.00 T Ω	10 G Ω	

* Full-scale value of insulation resistance is defined according the following equation:

$$R_{FS} = 2 \text{ G}\Omega * U_{test}[\text{V}]$$

DC test voltage:

Voltage value: 250 V to 5 kV.
 Accuracy: -0 / +10 % + 20 V.
 Output power: 5 W max.

Display range Test voltage (V)	Resolution	Accuracy
0 ÷ 5500 V	1 V	\pm (3 % of reading + 3 V)

Current:

Display range I (mA)	Resolution	Accuracy
1.00 ÷ 5.50 mA	10 μ A	\pm (5 % of reading + 0.05 nA)
100 ÷ 999 μ A	1 μ A	
10.0 ÷ 99.9 μ A	100 nA	
1.00 ÷ 9.99 μ A	10 nA	
100 ÷ 999 nA	1 nA	
10.0 ÷ 99.9 nA	0.1 nA	
0.00 ÷ 9.99 nA	0.01 nA	

Noise current rejection (resistive load)

Fil0	1.5
Fil1	2.5
Fil2	4.5
Fil3	5

Generator Capability vs Resistance

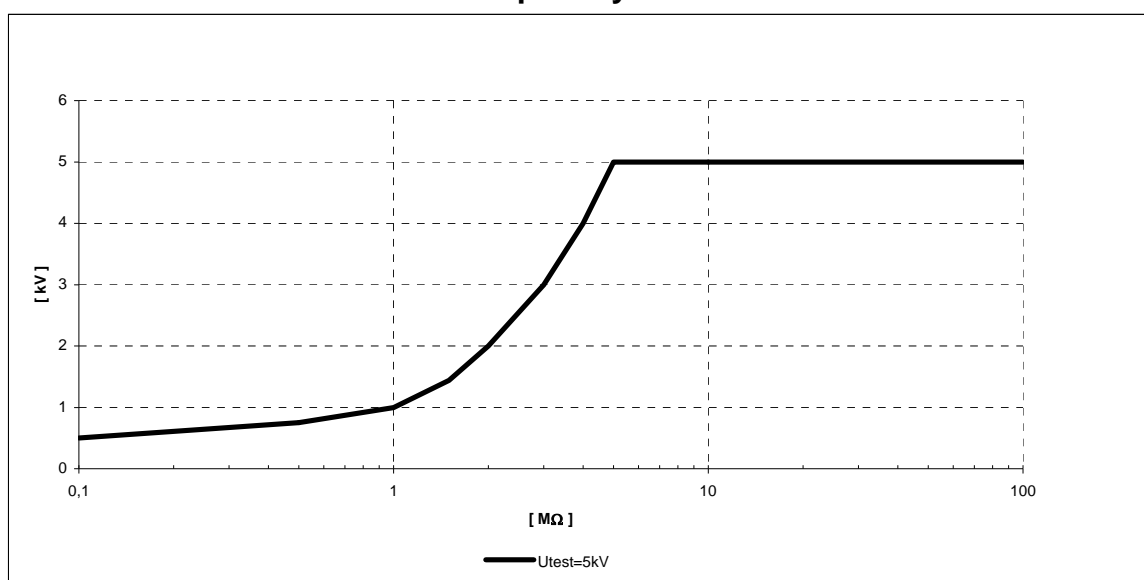

Dielectric absorption ratio DAR

Display range DAR	Resolution	Accuracy
0.01 ÷ 9.99	0.01	±(5% of reading + 2 digits)
10.0 ÷ 100.0	0.1	±(5% of reading)

Polarization index PI

Display range PI	Resolution	Accuracy
0.01 ÷ 9.99	0.01	±(5 % of reading + 2 digits)
10.0 ÷ 100.0	0.1	±(5% of reading)

Dielectric discharge test DD

Display range DD	Resolution	Accuracy
0.01 ÷ 9.99	0.01	±(5 % of reading + 2 digits)
10.0 ÷ 100.0	0.1	±(5% of reading)

Capacitance range for DD test: 5 nF to 50 μF.

Step voltage

DC test voltage:

Voltage value:

Any value within 1000 V (200 V, 400 V, 600 V, 800 V, 1000 V) and 5 kV (1000 V, 2000 V, 3000 V, 4000 V, 5000 V), steps by 125 V.

Accuracy:

-0 / +10 % + 20 V.

Display range Test voltage (V)	Resolution	Accuracy
0 ÷ 5500 V	1 V	±(3 % of reading + 3 V)

Withstanding voltage DC

DC test voltage:

Voltage value: 250V to 5kV, steps 25V.

Accuracy: -0 / +10 % + 20 V.

Display range Test voltage (V)	Resolution	Accuracy
0 ÷ 5500 V	1 V	±(3 % of reading + 3 V)

Leakage current

Display range Itrigg (mA)	Resolution	Accuracy
0.000 ÷ 0.009	1 μ A	±(3 % of reading + 3 digits)
0.01 ÷ 5.50	10 μ A	±(3 % of reading)

Voltage

Voltage AC or DC

Display range External Voltage (V)	Resolution	Accuracy
0 ÷ 600	1 V	±(3 % of reading + 4 V)

Frequency of external voltage

Display range (Hz)	Resolution	Accuracy
0 and 45 ÷ 65	0.1 Hz	±0.2 Hz

Note:

- for frequency between 0 and 45 Hz displayed <45 Hz
- for frequency over 65 Hz displayed >65 Hz
- for voltages under 10V frequency result is shown as ---

Input resistance: 3 M Ω ± 10 %**Capacitance**Measuring range C: 50 μ F*

Display range C	Resolution	Accuracy
0.0 ÷ 99.9 nF	0.1 nF	±(5 % of reading + 4 nF)
100 ÷ 999 nF	1 nF	
1.00 ÷ 50.00 μ F	10 nF	

C measured if R > 5 M Ω

*Full-scale value of capacitance is defined according to the following equation:

$$C_{FS} = 10 \mu\text{F} * U_{\text{test}}[\text{kV}]$$

8.2 General specifications

Battery power supply	7.2 V DC (6 × 1.2V _{DC} NiMH C size)
Mains power supply	90-260 V AC, 45-65 Hz, 40 VA (300V CAT III)
Protection classification	double insulation 
Over-voltage category	600 V CAT IV
Pollution degree.....	2
Degree of protection	IP 40 with case closed
Dimensions (w × h × d).....	31 x 13 x 25 cm
Weight (without accessories, with batteries)..	3 kg
Visual and sound warnings.....	yes
Display.....	LCD dot matrix with backlight - (160x116)
Memory.....	Non-volatile internal memory, 1000 numerical measurements with time and date.

ENVIRONMENT CONDITIONS

Working temperature range	-10 ÷ 50 °C
Nominal (reference) temperature range.....	10 ÷ 30 °C
Storage temperature range.....	-20 ÷ +70 °C.
Maximum humidity	90% RH (0 ÷ 40 °C) non-condensing
Nominal (reference) humidity range.....	40 ÷ 60 % RH
Nominal altitude	up to 2000m

AUTO-CALIBRATION

Auto-calibration of measuring system.....	every time after turning power on
---	-----------------------------------

CONNECTING SYSTEM

Two safety banana sockets	+OUT, -OUT (5kV CAT I, Double)
Two GUARD. banana sockets.....	GUARD (600V CAT IV, Double)
Guard resistance	200 kΩ ± 10 %

DISCHARGING

Every time after measurement completion.	
Discharging resistance:	300 kΩ ± 10 %

RS232 SERIAL COMMUNICATION

RS232 serial communication	galvanic separated
Baud rates:	4800, 9600, 19200 baud, 1 stop bit, no parity.
Connector:	standard RS232 9-pin D female.

USB COMMUNICATION

USB slave communication.....	galvanic separated
Baud rates	115000 baud,
Connector	standard USB connector - type B.

CLOCK

Built-in Real time clock	Displayed permanently and stored as a parameter in combination with the result.
--------------------------------	--