



OMICRON

CMC 356

User Manual



Article Number VESD2003 - Version CMC356.AE.4

© OMICRON electronics. All rights reserved.

This manual is a publication of OMICRON electronics.

All rights including translation reserved. Reproduction of any kind, e.g., photocopying, microfilming, optical character recognition and/or storage in electronic data processing systems, requires the explicit consent of OMICRON electronics.

Reprinting, wholly or in part, is not permitted. The product information, specifications, and technical data embodied in this manual represent the technical status at the time of writing and are subject to change without prior notice.

We have done our best to ensure that the information given in this manual is useful, accurate and entirely reliable. However, OMICRON electronics does not assume responsibility for any inaccuracies which may be present.

The user is responsible for every application that makes use of an OMICRON product.

OMICRON electronics translates this manual from the source language English into a number of other languages. Any translation of this manual is done for local requirements, and in the event of a dispute between the English and a non-English version, the English version of this manual shall govern.

TABLE OF CONTENTS

Preface	7
Safety Instructions	8
1 Designated Use	11
2 Introduction	12
2.1 Options Available for the CMC 356 Test Set.....	12
3 Operating the CMC 356	13
3.1 System Components	13
3.2 Safe Use of the Connecting Cables	14
3.2.1 Test Lead Adapter for Non-Safety Sockets	14
3.3 Regular Test Leads for Safety Sockets	15
3.3.1 Terminal adapters.....	15
3.3.2 M4 (0.15") Cable Lug Adapters	16
3.3.3 M5 (0.20") Cable Lug Adapters	16
3.4 Starting the Test System	17
4 Setup and Function	19
4.1 Block Diagram	20
4.1.1 Voltage Output (Voltage Amplifier)	21
4.1.2 Current Output (Current Amplifier).....	22
4.1.3 Binary / Analog Input (Binary Inputs 1 - 10).....	23
4.1.4 Binary Output.....	23
4.1.5 AUX DC (DC Power for Test Objects)	24
4.1.6 CPU	25
4.1.7 Power Supplies (DC-DC).....	25
4.2 Signal Generation.....	25
4.2.1 Accuracy and Signal Quality	26
5 Connections and Interfaces	27
5.1 Front Panel Connections	27
5.1.1 Generator Combination Socket for VOLTAGE OUTPUT and CURRENT OUTPUT	30

5.2	Connections on the Back Panel	32
5.2.1	Ethernet Ports ETH1 and ETH2	32
5.2.2	! Button	33
5.2.3	Associate Button	33
5.2.4	Status LED A, B	34
5.2.5	Ethernet / Network Settings	34
5.2.6	SELV Interfaces	36
5.2.6.1	External Interface ("ext. Interf.")	36
5.2.6.2	LL out 1-6 (Low Level Outputs 1-6)	37
5.2.6.3	LL out 7-12 (Low Level Outputs 7-12) - Option "LLO-2"	37
6	Technical Data	39
6.1	Main Power Supply	39
6.2	Insulation Coordination	40
6.3	Outputs	41
6.3.1	Extended Frequency Range	42
6.3.2	Current Outputs	43
6.3.3	Voltage Outputs	48
6.3.3.1	Power Diagram for Three-Phase Operation	49
6.3.3.2	Power Diagram for Single-Phase Operation	50
6.3.4	Operational Limits in Conjunction with Mains Supply	51
6.3.5	Low Level Outputs "LL out" for External Amplifiers	52
6.3.6	Low-Level Binary Outputs ("ext. Interf.")	54
6.3.7	Binary Output Relays	56
6.3.8	DC Supply (AUX DC)	57
6.4	Inputs	58
6.4.1	Binary Inputs	58
6.4.2	Counter Inputs 100 kHz (Low Level)	61
6.5	Technical Data of the Ethernet Ports	63
6.5.1	The NET-1B Board	63
6.5.2	The NET-1 Board	64
6.6	Environmental Conditions	65
6.6.1	Climate	65
6.6.2	Shock and Vibration	65
6.7	Mechanical Data	65
6.8	Cleaning	65
6.9	Safety Standards, Electromagnetic Compatibility (EMC) and Certificates	66
6.10	Option ELT-1	67

6.10.1	General Data	68
6.10.2	Analog DC Input (VDC, IDC)	69
6.10.3	Accuracy of the Analog DC Input.....	70
6.10.4	Measuring Currents	71
6.10.5	Accuracy of Binary/Analog Inputs with Option ELT-1	72
6.10.6	Multimeter Mode	73
6.10.6.1	Accuracy of AC Measurements	74
6.10.6.2	Channel Cross-Talk.....	76
6.10.6.3	Accuracy of Phase Measurement.....	77
6.10.6.4	Accuracy of Frequency Measurement.....	79
6.10.6.5	Accuracy of Power Measurement.....	80
6.10.7	Harmonic Analysis	84
6.10.7.1	Accuracy of Frequency Measurement.....	85
6.10.7.2	Accuracy of Amplitude Measurement.....	86
6.10.7.3	Accuracy of Phase Measurement.....	87
6.10.8	Transient Recording	88
6.10.9	Trend Recording	89
6.11	Option LLO-2 (Low Level Outputs).....	90
7	Increasing the Output Power, Operating Modes	91
7.1	Safety Instructions for High Current Output.....	91
7.2	Single-Phase Operation of the CMC 356	92
7.2.1	1 x 32 A High Burden Mode (L-L-L-L).....	92
7.2.2	1 x 64 A High Burden and High Current Mode (L-L).....	93
7.2.3	1 x 128 A High Current Mode (LL-LN)	94
7.2.4	Single-Phase Voltage	95
7.3	Two-Phase Operation.....	96
7.3.1	2 x 64 A High Current Mode (LL-LN)	96
7.3.2	2 x 32 A High Burden Mode (L-L)	97
7.4	Three-Phase Current Mode with High Burden	98
7.5	Operation with External Amplifiers	99
8	Troubleshooting	101
8.1	Troubleshooting Guide	101
8.2	Potential Errors, Possible Causes, Remedies.....	102
8.3	Overheating	103

9	CMC 356-Related Products and Accessories	105
9.1	CMA Current Amplifiers & CMS Voltage Amplifiers	105
9.2	CMControl-6	106
9.3	Time Synchronization Accessories.....	107
9.3.1	CMGPS.....	107
9.3.2	CMIRIG-B	109
9.4	100TX to 100FX-SC Converter	111
9.5	Current Clamp C-PROBE1	112
9.6	Accessories for Meter Testing	113
9.6.1	Scanning Head OSH256	113
9.6.2	Interface Box IFB256	114
9.6.3	Scanning Head TK 326.....	115
9.6.4	Scanning Head TVS 6.15/1	116
9.6.5	Adapter Cable for Scanning Heads	117
9.6.6	CMLIB B	118
9.6.7	CMLIB A	119
9.6.8	CPOL Polarity Tester	120
9.6.9	Connection Cable for REF 54x Relays (ABB) with Low Level Signal Inputs ...	121
9.6.10	C-Shunt.....	122
9.7	Wiring Accessories	123
9.7.1	Standard Delivery Scope	123
9.7.2	Optional CMC Wiring Accessory Package	124
9.8	Ordering Information.....	127
	Appendix	133
	Contact Information / Technical Support	137
	Index	139

PREFACE

The purpose of this reference manual is to familiarize users with the *CMC 356* test set and to show how to properly use it in various application areas.

The manual contains important tips on how to use the *CMC 356* safely, properly, and efficiently. Its purpose is to help you avoid danger, repair costs, and down time as well as to help maintain the reliability and life of the *CMC 356*.

This manual is to be supplemented by existing national safety standards for accident prevention and environmental protection.

The reference manual should always be available at the site where the *CMC 356* is used. It should be read by all personnel operating the test set.

Note: The OMICRON *Test Universe* software also installs a PDF version of this reference manual. It can directly be opened by a mouse-click from the help topic "User Manuals of OMICRON Test Universe".

In addition to the reference manual and the applicable safety regulations in the country and at the site of operation, the usual technical procedures for safe and competent work should be heeded.

Note: This reference manual describes the *CMC 356* hardware - that is, the physical test set. In order to get familiar with the software for controlling and configuring the *CMC 356*, please refer to the software manuals and/or the OMICRON *Test Universe* Help.

For Your Safety Please Note

The *CMC 356* test set can output life-hazardous voltages and currents.



Throughout the manual, this symbol indicates special safety-relevant notes/directions linked to the possibility of touching live voltages and/or currents. Please thoroughly read and follow those directions to avoid life-hazardous situations.



This symbol indicates potential hazards by electrical voltages/currents caused by, for example, wrong connections, short-circuits, technically inadequate or faulty equipment or by disregarding the safety notes of the following sections.

SAFETY INSTRUCTIONS



Before operating the *CMC 356* test set, carefully read the following safety instructions.

Only operate (or even turn on) the *CMC 356* after you have read this reference manual and fully understood the instructions herein.

The *CMC 356* may only be operated by trained personnel. Any maloperation can result in damage to property or persons.

Rules for Use

- The *CMC 356* should only be used when in a technically sound condition. Its use should be in accordance with the safety regulations for the specific job site and application. Always be aware of the dangers of the high voltages and currents associated with this equipment. Pay attention to the information provided in the reference manual and the software documentation.
- The *CMC 356* is exclusively intended for the application areas specified in section 1, "Designated Use" on page 11. The manufacturer/distributors are not liable for damage resulting from unintended usage. The user alone assumes all responsibility and risk.
- The instructions provided in this reference manual and the associated software manuals are considered part of the rules governing proper usage.
- Do not open the *CMC 356* or remove any of its housing components.

Orderly Practices and Procedures

- The reference manual (or its "electronic PDF pendant", which is installed to your computer with the OMICRON Test Universe software) should always be available on site where the *CMC 356* is used.



Note: The OMICRON *Test Universe* software also installs a PDF version of this reference manual. It can directly be opened by a mouse-click from the help topic "User Manuals of OMICRON Test Universe". The *Test Universe* Help can be launched by clicking **Help** on the *Start Page*.

- Personnel assigned to using the *CMC 356* must have read this reference manual and fully understood the instructions herein.
- Do not carry out any modifications, extensions or adaptations at the *CMC 356*.

Operator Qualifications

- Testing with the *CMC 356* should only be carried out by authorized and qualified personnel.
- Personnel receiving training, instruction, direction, or education on the *CMC 356* should remain under the constant supervision of an experienced operator while working with the equipment.

Safe Operation Procedures

- Follow the instructions in sections 3.2 and 3.4 that describe the safe use of the connecting cables and how to set the *CMC 356* into operation.
- The *CMC 356* must only be used from a power outlet that has a protective earth.
- Do not block the access to safety-relevant test set components like the main power switch or the power cord. In cases of an emergency, these components need free and quick access.
- Do not connect any of the front panel VOLTAGE/CURRENT OUTPUTS 1 ... 3 or VOLTAGE OUTPUT 4, respectively, to protective earth. The N sockets, however, may be connected to protective earth.
- When connecting to the banana plug sockets, only use cables with 4 mm/0.16 " safety banana connectors and plastic housing. Always insert plugs completely.
- Before connecting and disconnecting test objects, verify that all outputs have been turned off. Never connect or disconnect a test object while the outputs are active.
- When disconnecting power supply cables or test leads, always start from the device feeding the power or signal.
- All sockets on the front panel are to be considered dangerous with working voltages up to 300 V_{rms}. Only use cables that meet these respective requirements to connect to the equipment.
- Red Signal Light :
If the voltage on any of the four voltage outputs or on the "AUX DC" output exceeds 42 V, the associated signal light lights up.
- Do not insert objects (e.g., screwdrivers, etc.) into the sockets or into the ventilation slots.
- Do not operate the *CMC 356* under wet or moist conditions (condensation).

- Do not operate the *CMC 356* when explosive gas or vapors are present.
- The SELV interface (SELV = Safety Extra Low Voltage) of the *CMC 356* - "Host Interf." or "ETH1", "LL out" (Low Level Outputs), "ext. Interf." - should only have external devices connected that meet the requirements for SELV equipment according to EN 60950 or IEC 60950.
- For applications drawing DC current: The load may not exceed 3 mA because of dangerous feedback current.
- When setting up the *CMC 356*, make sure that the air slots on the back, top, and bottom of the test set remain unobstructed.
- Voltages up to 1 kV can be present inside the *CMC 356*! Therefore, opening the *CMC 356* is only permitted by qualified experts either at the factory or at certified external repair centers.
- If the *CMC 356* is opened by the customer, all guarantees are invalidated.
- *CMC 356* Ethernet functionality (see section 5.2.1, "Ethernet Ports ETH1 and ETH2" on page 32):
 - It is a product of laser class 1 (EN 60825, IEC 60825).
 - Connect ETH1 **only** to Ethernet ports.
- If the *CMC 356* seems to be functioning improperly, please contact the OMICRON Technical Support (see section "Contact Information / Technical Support" on page 137).

Changing the Power Fuse

- Unplug the power cord between the test set and the power source.
- The fuse is located at the back of the test set.
- Fuse type: **T12.5 AH 250 V** (wire fuse 5 × 20 mm).

For safety reasons please use only fuse types recommended by the manufacturer. Refer to 6.1, "Main Power Supply" on page 39 for more information.

1 DESIGNATED USE

The *CMC 356* is a computer-controlled test set for the testing of:

- protection relays
- transducers
- energy meters
- PQ (power quality) analyzers.

In addition to the test functions, optional high-performance measurement functions [0 Hz (DC) ... 10 kHz] for ten analog inputs are available.

The *CMC 356* is part of the OMICRON *Test Universe* which, in addition to the physical test set, consists of a test software for a computer with Windows¹ operating system, and, when needed, external voltage and/or current amplifiers, GPS or IRIG-B synchronization units or other accessories.

Features of the *CMC 356*:

- Output of test quantities:
 - 4 × voltage
 - two galvanically separated three-phase current outputs.
- Capability of protection testing with IEC 61850 devices.
- Control of external amplifiers (up to 12 additional test signals) through the low-level interface.
- Supply of DC voltages to the test object.
- Output of binary signals.
- Capture of binary signals and counter impulses.
- Option ELT-1:
Measurement and analysis of DC and AC voltages and currents by means of a clip-on probe (refer to section 6.10, "Option ELT-1" on page 67) or a measurement shunt.

Any other use of the *CMC 356* is considered improper and may result in damage to property or persons.

¹ Windows is a US registered trademark of Microsoft Corporation.

2 INTRODUCTION

The *CMC 356* is a part of the *OMICRON Test Universe* which, in addition to the physical test set, consists of a test software for a computer with Microsoft Windows operating system, and, when needed, external voltage and/or current amplifiers, GPS or IRIG-B synchronization units or other accessories (refer to section 9, "CMC 356-Related Products and Accessories" on page 105).

This reference manual describes the hardware of the *CMC 356*. The configuration and control of the *CMC 356* is carried out by the test software of the *OMICRON Test Universe*. For more detailed information, please read the user manuals and the *OMICRON Test Universe* Help.



Note: The *OMICRON Test Universe* software also installs a PDF version of this reference manual. It can directly be opened by a mouse-click from the *Test Universe* Help topic "User Manuals".

2.1 Options Available for the CMC 356 Test Set

The following options are available for the *CMC 356* test set:

- **ELT-1**

This hardware option enables:

- Measurement of analog signals using the combined BINARY / ANALOG INPUT sockets.
- High-precision measurement of DC signals using the ANALOG DC INPUT sockets.

For detailed information, please refer to section 6.10, "Option ELT-1" on page 67).

- **LLO-2 (low level outputs 7-12)**

SELV interface connector holding two independent generator triples (SELV = Safety Extra Low Voltage). These six additional high accuracy analog signal sources can serve to either control an external amplifier or to directly provide small signal outputs.

For more information please refer section 6.3.5, "Low Level Outputs "LL out" for External Amplifiers" on page 52.

- **FL-6**

In a number of countries (e.g., Japan), the export of multiphase generators able to output steady signals with a frequency between 600 Hz and 2000 Hz is not permitted.

The **FL-6** option constraints the maximum fundamental frequency that the test set can generate to 599 Hz. Test sets with the FL-6 option can therefore be exported without any restrictions (refer to 6.3, "Outputs" on page 41).

3 OPERATING THE CMC 356



Only operate (or even turn on) the *CMC 356* after you have read this reference manual and fully understood the instructions herein.

3.1 System Components

Before operating the *CMC 356* for the first time, use the packing list to verify that all components of the test system are available.

To set the *CMC 356* into operation you need the following components:

- *CMC 356* with (mains) power cable
- Connecting cable *CMC 356* ↔ PC
- Connecting cable *CMC 356* ↔ test object
- PC equipped with an Ethernet port and the OMICRON *Test Universe* software.

3.2 Safe Use of the Connecting Cables

3.2.1 Test Lead Adapter for Non-Safety Sockets

The optional CMC Wiring Accessory Package includes flexible test lead adapters of 5 cm/2 " length with a retractable sleeve (6 x black, 6 x red).

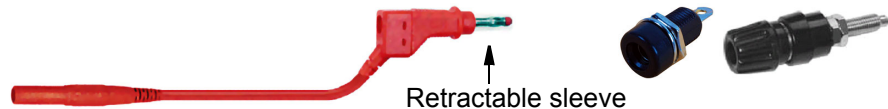

These test leads are to be used as **adapters**, only. They are intended to make the 4 mm/0.16 " banana plugs of the standard test leads fit into non-safety sockets (see illustration above).

Never directly insert one of these retractable sleeves into a CMC 356 output socket at the front of the test set. This does not comply with the designated purpose of these leads and is contrary to the safety regulations.



Plug **only the regular test leads** of 2.0 m/6 ft. length into the CMC 356 output safety sockets.

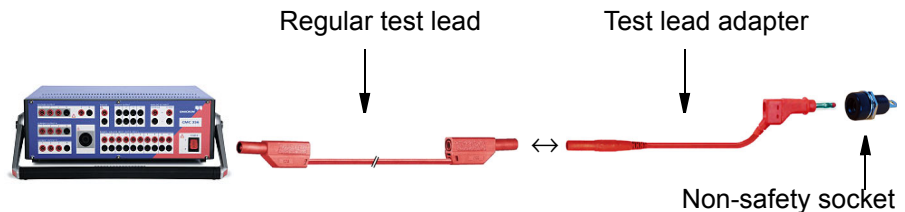

3.3 Regular Test Leads for Safety Sockets

Use the regular test leads of 2.0 m/6 ft. length to connect the *CMC 356* output to other safety sockets of, for example, amplifiers, test objects or to banana adapters in control cabinets.

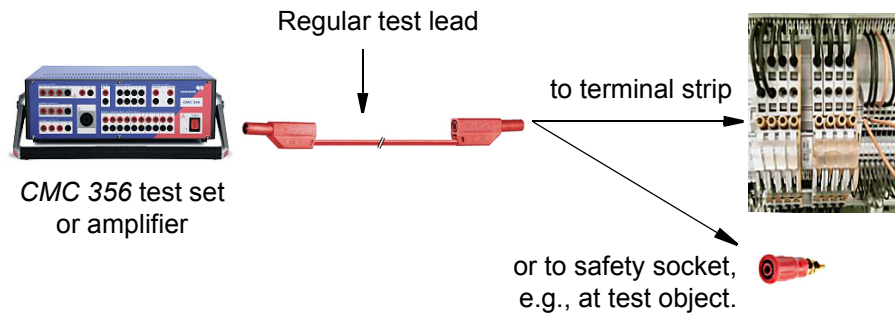

3.3.1 Terminal adapters

The optional *CMC* Wiring Accessory Package includes flexible terminal adapters to connect the regular test leads to screw-clamp terminals.

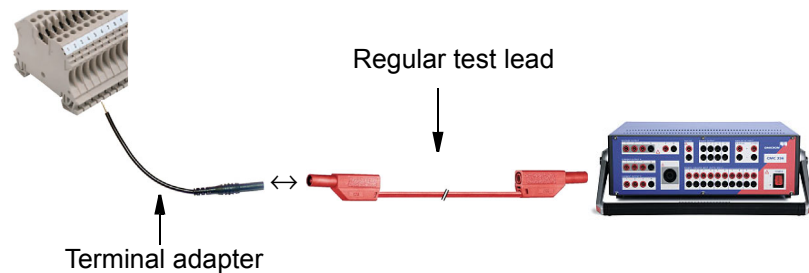

The terminal adapters have blank ends. Therefore, turn off the voltage before connecting these adapters. Always insert an adapter with its blank end into the terminal strip first, and fasten it before connecting it to a test lead.

3.3.2 M4 (0.15") Cable Lug Adapters

The optional CMC Wiring Accessory Package includes M4 (0.15") cable lug adapters to connect regular test leads to screw-clamp terminals of SEL/ABB/GE relays (and others).

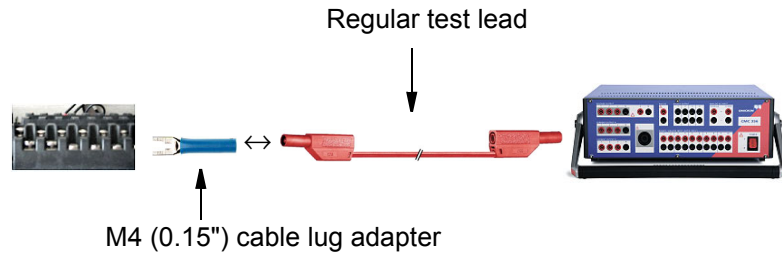

The cable lugs have blank ends. Therefore, turn off the voltage before connecting such a lug. Always insert the cable lug with its blank end into the terminal strip first, and fasten it, before connecting it to a test lead.

3.3.3 M5 (0.20") Cable Lug Adapters

The optional CMC Wiring Accessory Package includes M5 (0.20") cable lug adapters to connect regular test leads to common and most widespread screw-clamp terminal types.

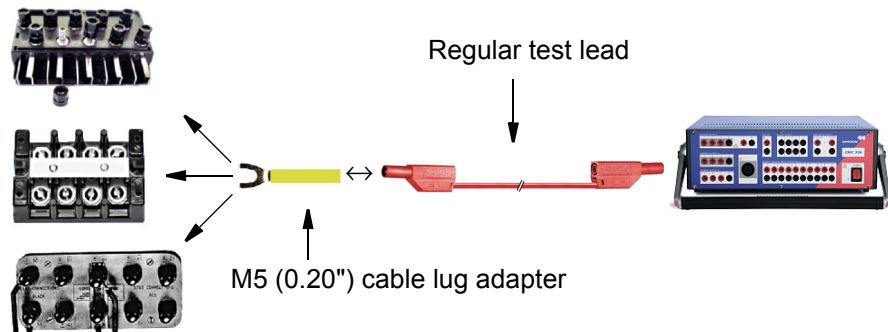

The cable lugs have blank ends. Therefore, turn off the voltage before connecting such a lug. Always insert the cable lug with its blank end into the terminal strip first, and fasten it, before connecting it to a test lead.

3.4 Starting the Test System

The following description assumes that the computer has been set up and that the test software for the OMICRON *Test Universe* has been installed.

Detailed instructions for installing the software for the OMICRON *Test Universe* can be found in the software manual "The Concept".

This description refers both to the computer and to the *CMC 356*. It does not take into consideration any external devices. If the system is driven by external amplifiers, follow the instructions in section 7.5, "Operation with External Amplifiers" on page 99.



When setting up the *CMC 356*, it is most important to make sure that the ventilation slots remain unobstructed.

Connecting the System Components:

Figure 3-1:
Connecting the *CMC 356*
to the computer

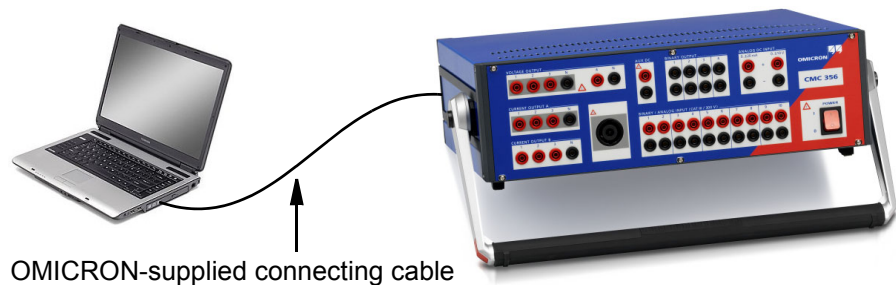

OMICRON-supplied connecting cable

1. Connect the *CMC 356* to the PC with the supplied connecting cable¹:
 - *CMC 356*: Connector ETH1 at the rear side of the test set
 - PC: Ethernet port (labeled "EtherNET", "LAN" or similar).



For instructions to help you to incorporate network-capable CMC test sets, such as the *CMC 356* into a computer network, please refer to the manual "Network-based CMC Test Sets". This manual is provided in PDF format; its name is **Network-based test sets.pdf**. It is available on your hard disk at ***Test Universe installation folder*\Test Universe\Doc**.

¹ To ensure the required EMC compatibility, we recommended to only use the OMICRON-supplied connecting cable.

2. Connect the *CMC 356* test set to the mains.
3. Turn on both devices.
4. Start the OMICRON *Test Universe* software.

A comprehensive hardware test is carried out on the *CMC 356*. In the process, switching sounds from relays in the CMC test set can be heard. If any irregularities are determined during the course of this self-test, the software displays a corresponding error message on the PC monitor (refer to section 8, "Troubleshooting" on page 101).

4 SETUP AND FUNCTION

The computer-controlled OMICRON test system employs the concept of a functional division between the software running on the computer and the *CMC 356* hardware connected to the test object.

OMICRON *Test Universe* test software running on the computer

- controls the test signals
- processes measurement data
- creates reports
- generates data entries.

The *CMC 356* test set

- creates test signals (currents, voltages, binary signals)
- measures the reaction (analog and binary) from the test object
- supplies DC-current to test objects.

4.1 Block Diagram

Figure 4-1:
Main block diagram of
the CMC 356

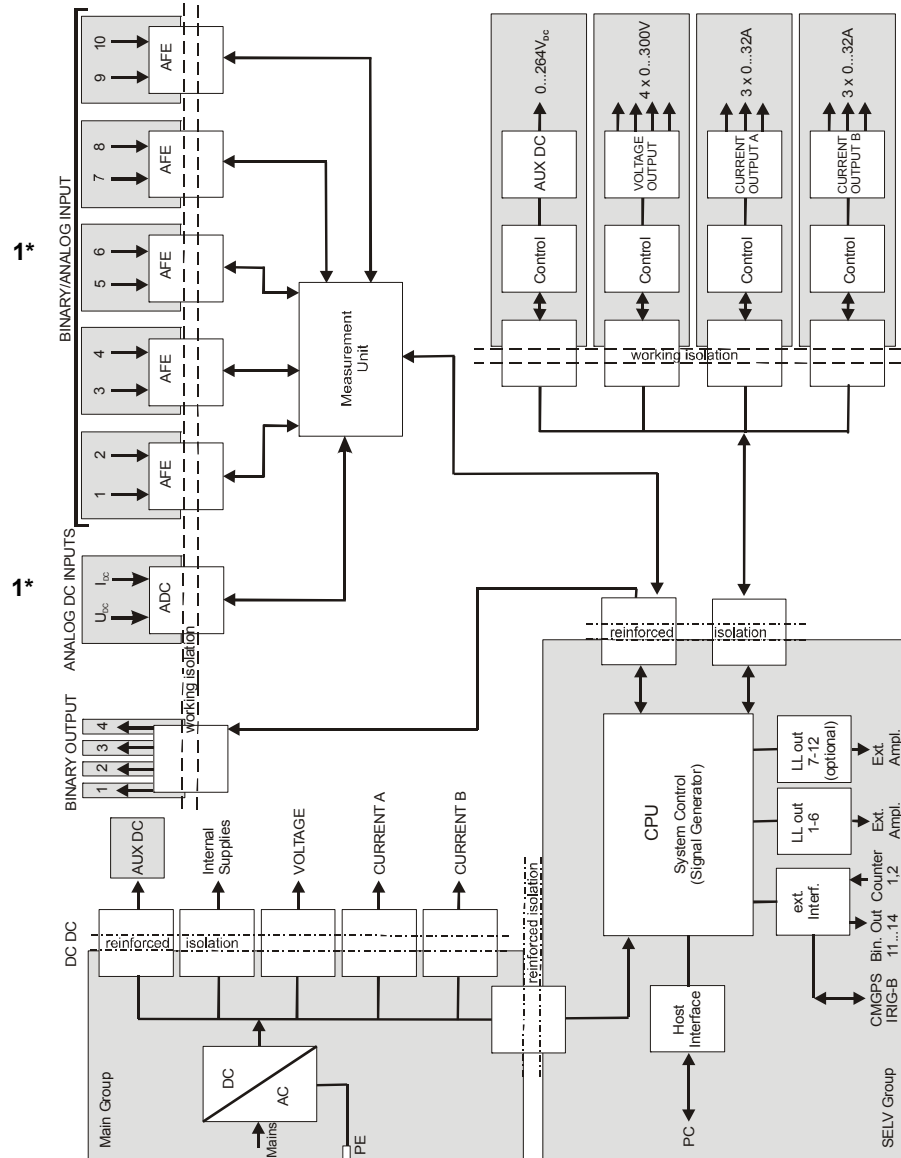

1* Note regarding the hardware option ELT-1:

The hardware option ELT-1 enables the measurement of analog signals using the CMC 356. In the standard configuration (CMC 356 without option ELT-1), the inputs BINARY/ANALOG INPUT 1 - 10 can only be used as binary inputs, and DC inputs are not available.

The block schematic diagram in figure 4-1 shows all externally accessible signals with gray shading. Every gray area represents a galvanic group that is isolated from all of the other galvanic groups.

The power connection ("power supply group") and the connections for "SELV group" (SELV = Safety Extra Low Voltage) are available on the back of the test set. All other gray shaded groups are available on the front of the test set. The safety relevant isolated circuits (power ↔ SELV, power ↔ front plate, and front plate ↔ SELV) are marked as "reinforced isolation" in the block diagram.

4.1.1 Voltage Output (Voltage Amplifier)

Figure 4-2:
Voltage amplifier
(voltage outputs)

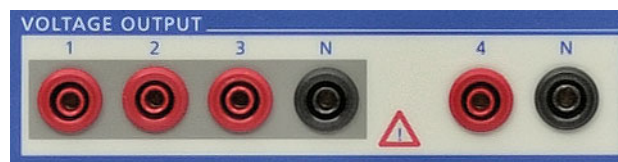

The four voltage outputs have a common neutral N and are galvanically separated from all other outputs of the CMC 356. The two black sockets labeled "N" are galvanically connected with one another.

The voltage amplifier and the current amplifiers are linear amplifiers with DC coupling. The voltage outputs work in two ranges:

- Range 1: 4 x 0 ... 150 V
- Range 2: 4 x 0 ... 300 V

Protecting the Voltage Outputs

All voltage outputs are protected for open circuits, L-N short-circuits, and overload. Should the heat sink overheat, a thermal switch turns off all outputs.

Overload Warning Flagged in the Software

When a voltage output is overloaded, a corresponding warning is displayed in the user interface of the test software of the OMICRON *Test Universe* (like described in, for example, section 8.3, "Overheating" on page 103).



Do not connect any of the VOLTAGE OUTPUTS 1 ... 3 or VOLTAGE OUTPUT 4, respectively, to protective earth. The N sockets, however, may be connected to protective earth.

4.1.2 Current Output (Current Amplifier)

Figure 4-3:
CMC 356 current outputs
groups A & B

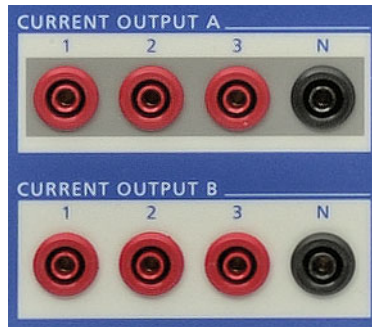

CURRENT OUTPUT A

CURRENT OUTPUT B

Two galvanically separated three-phase current outputs, each with their own neutral (N).

Each output is galvanically separated from all other connections of the CMC 356.

The current amplifiers are implemented as switched mode amplifiers with DC coupling. With this technology it is possible to achieve high power density in a very compact structure. The DC coupling enables a precise reproduction of transients or DC offsets.

Protecting the Current Outputs

All current outputs are protected for open circuits, short-circuits, and overload. If the heat sink overheats, a thermo switch turns off all outputs. The output sockets are internally protected against currents $> 45A_{\text{peak}}$ ($32A_{\text{rms}}$; the CMC 356 switches off with the error message "current on neutral too high").

In non-operative state, relay contacts (as illustrated in figure 5-3) protect the current amplifier from external power by shortening the outputs to N.

Caution: If there is an in-feed from an external source, the current outputs can be damaged or destroyed.



Overload Warning Flagged in the Software

When a current output is overloaded, a corresponding warning is displayed in the user interface of the test software of the OMICRON *Test Universe* (like described in, for example, section 8.3, "Overheating" on page 103).



Please see also section 7.1, "Safety Instructions for High Current Output" on page 91.

4.1.3 Binary / Analog Input (Binary Inputs 1 - 10)

Figure 4-4:
Binary/analog inputs 1 - 10

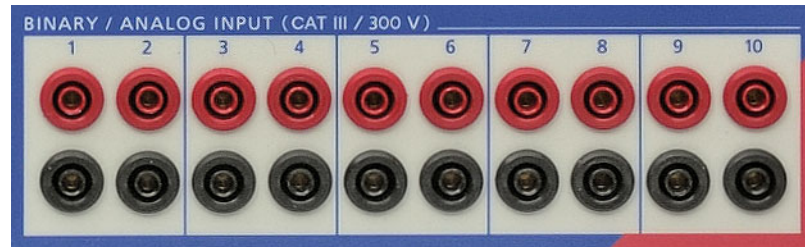

The ten binary inputs are divided into five groups of two, each group galvanically separated from the others. If the hardware option ELT-1 is installed, all inputs can be configured individually by the software as binary or analog measurement inputs (refer to section 6.10, "Option ELT-1" on page 67).

The input signals are monitored with a time resolution of 100 μ s and then evaluated in the CPU.

The binary inputs are configured from the Hardware Configuration module of the OMICRON *Test Universe* software. When doing so, it can be specified whether the contacts are potential-sensitive or not. When the contacts are potential-sensitive, the expected nominal voltage and pick-up threshold can be set for each binary input.

Moreover, the binary inputs 1 – 10 can be used as counter inputs for input frequencies up to 3 kHz.

More detailed information about the configuration of the binary inputs can be found in the OMICRON *Test Universe* Help.

4.1.4 Binary Output

Figure 4-5:
Binary outputs

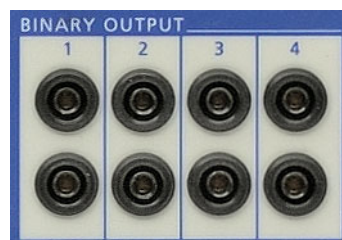

Four binary outputs are available for use as potential-free relay contacts.

More detailed information about the configuration of the binary outputs can be found in the OMICRON *Test Universe* Help.

4.1.5 AUX DC (DC Power for Test Objects)

Figure 4-6:
DC power for test objects
(AUX DC)



Test objects that require an auxiliary DC voltage can be fed from the AUX DC output.

The DC voltage that is applied over the AUX DC output can vary from 0 to 264 Volts and is configured using the software.

The AUX DC output is galvanically separated from all other outputs.

The power-up default

By means of the test tool *AuxDC* you can set a so-called power-up default. When the test set is powered-up the next time, the auxiliary DC output is automatically set to this default value. This default value applies until it is deliberately changed again.

Setting a power-up default value means, that immediately after the test set is switched on, this voltage is applied to the auxiliary DC voltage output, regardless whether a computer is connected to it or not.

Caution: The selected voltage can be life-threatening!

Consider storing a power-up default voltage of higher than 0 V a potential danger to future users that may connect other devices to this CMC test set.

We strongly recommend to always set the default value to 0 V before storing the device, or to otherwise attach a warning label to the device housing, such as "*This unit outputs an AuxDC voltage of ___ V immediately after powering-up*".

 If the voltage on the "AUX DC" output exceeds 42 V, the associated signal light lights up.

More information about the configuration of the AUX DC supply can be found in the OMICRON *Test Universe AuxDC* Help.



4.1.6 CPU

The *CMC 356* CPU (**C**entral **P**rocessing **U**nit) carries out the following tasks:

- Communication with the computer or a network via the Ethernet ports “ETH1” and “ETH2”.
- Digital signal generation for all outputs of the test set (including control signals for external amplifiers).
- Generation of a high-accuracy central clock signal with synchronization options using the *CMGPS* synchronization unit or the *CMIRIG-B* interface box (refer to 9.3, "Time Synchronization Accessories" on page 107).
- Monitoring and control of all systems, including external amplifiers, if applicable.

4.1.7 Power Supplies (DC-DC)

An AC/DC converter generates the required DC voltage from 85 to 264 V_{AC} supply voltage (see section 6.1) and ensures adequate EMC filtering.

The power supply to the different modules, that each are part of their own galvanic groups, are implemented using DC-DC converters with reinforced insulation.

4.2 Signal Generation

The generation of sine wave signals with high amplitude and phase accuracy is required in order to achieve output signals with the specified accuracy.

In order to fulfill the requirement for phase-coupled signal sources, signal generation is digitally implemented.

For this, the *CMC 356* employs a high-performance digital signal processor (DSP).

With digital signal generation the system is very flexible. An exact correction of the amplitude, offset, and phase can be carried out in a digital manner through the use of device-specific parameters (i.e., gain, offset, and null phase angle on every channel).

The digital correction assures the best possible long-term drift behavior.

In addition to sine waves, any other periodic or transient signal can be generated.

4.2.1 Accuracy and Signal Quality

The *CMC 356* is a very precise test set with excellent long-term and temperature drift behavior.

To achieve this accuracy, the philosophy was not only to solve signal generation digitally, but also to implement the distribution of signals to the various modules using digital methods. In doing so, the goal of galvanic separation of the individual generator groups was also achieved without loss of accuracy.

In achieving the amplitude accuracy, the drift behavior (temperature and long-term) is of major importance in the voltage references, the digital-analog converters (DAC), the accurate voltage dividers in the voltage amplifiers, and the current shunts in the current amplifiers.

The actual (typical) data is in general about a factor of 3 better than the guaranteed data.

The associated exact measurement media are required for the assurance of the accuracy in the production. The measurement media used by OMICRON are regularly calibrated by an accredited calibration institute so that tracing to international standards can be assured.

5 CONNECTIONS AND INTERFACES

5.1 Front Panel Connections

Figure 5-1:
Front view of the CMC 356

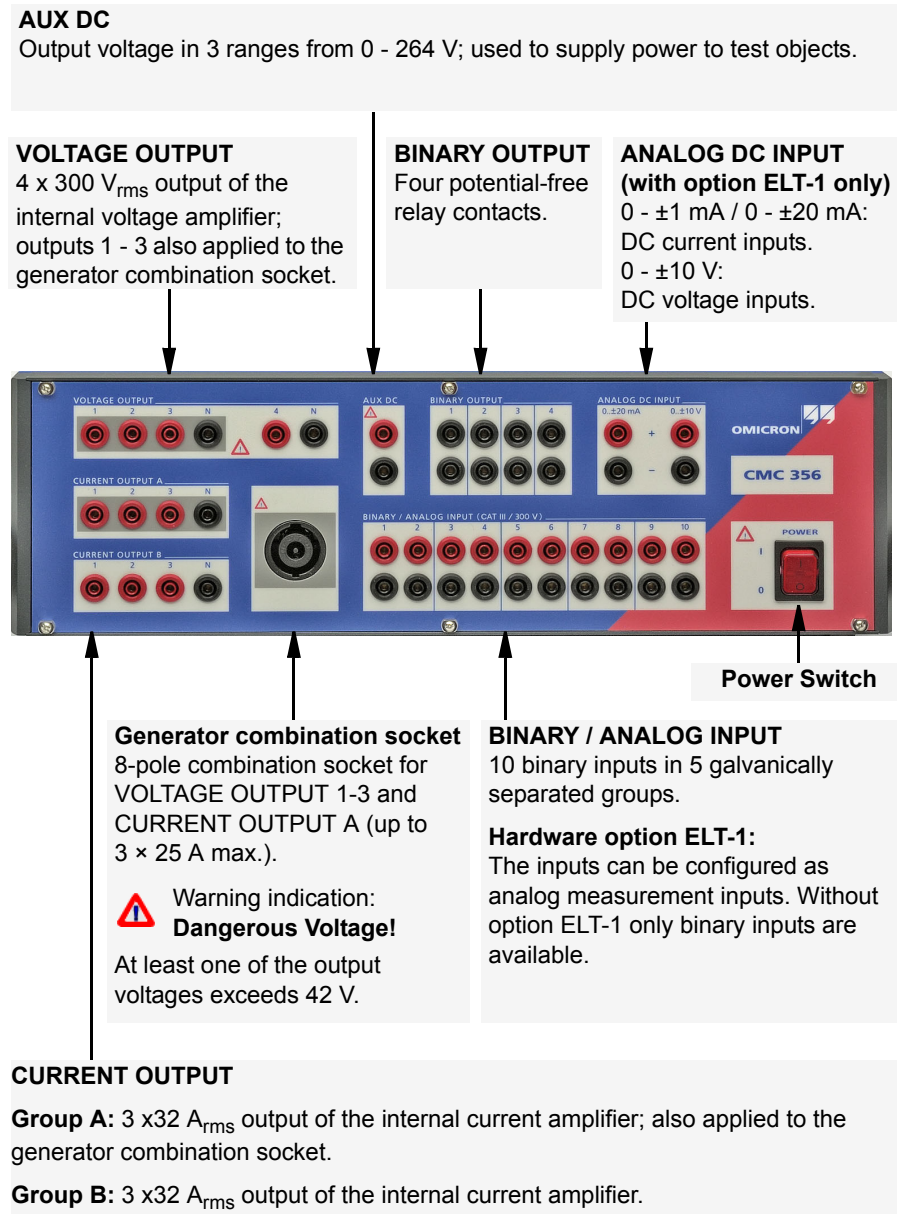
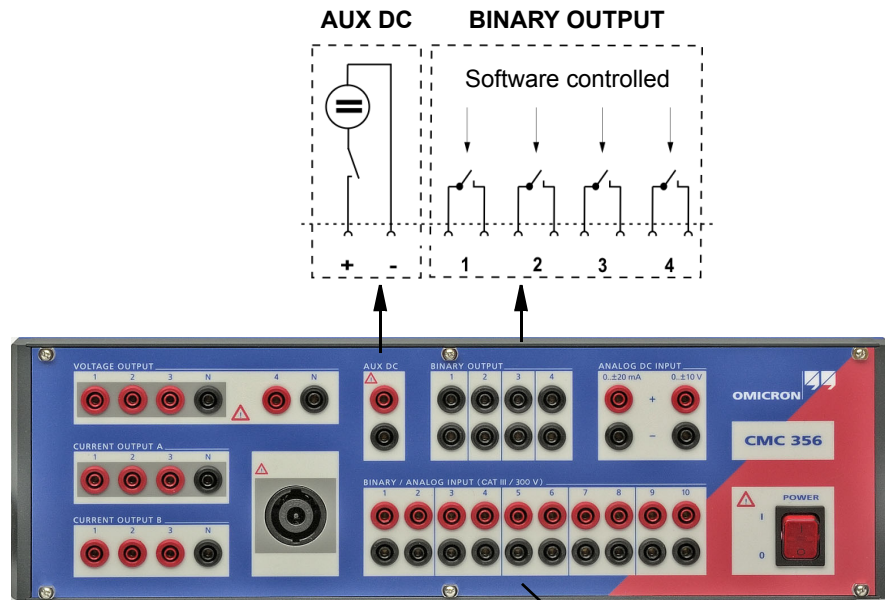

Figure 5-2:
Simplified circuit diagrams
of binary inputs and
outputs (CMC 356
standard, without option
ELT-1 installed)



Each binary input can be configured individually for wet or dry operation.

Two inputs (1 + 2, 3 + 4, ...) are one potential group. The inputs grouped in one potential group share a common ground.

BINARY/ANALOG INPUT

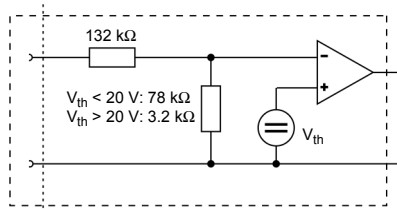
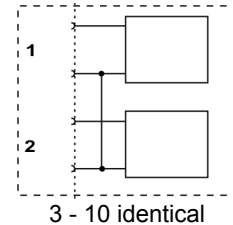

Circuit diagram of a binary input with programmable threshold voltage (wet operation)

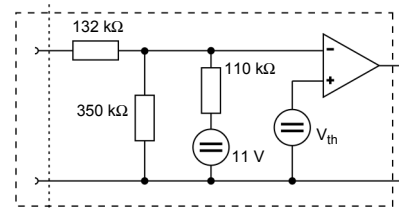

Circuit diagram of a binary input for potential-free operation (dry)

Note: For simplified circuit diagrams of the inputs BINARY/ANALOG INPUTS and ANALOG DC INPUT of the CMC 356 with hardware option ELT-1 installed, please refer to Figure 6-20 on page 72.

Figure 5-3:
Simplified diagrams of
current and voltage
outputs

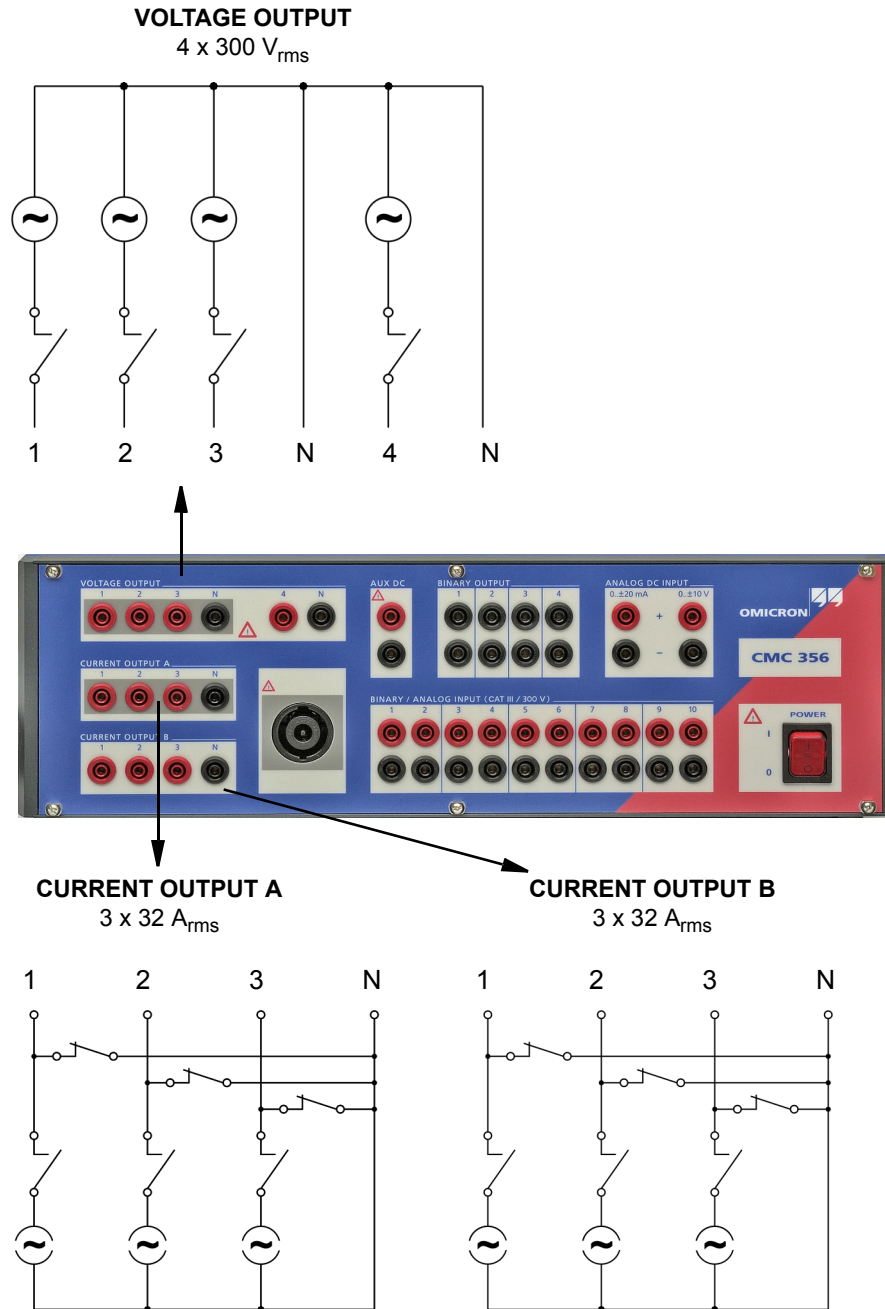

In non-operative state, relay contacts (as illustrated in figure 5-3) protect the current amplifier from external power by shortening the outputs to N.

5.1.1 Generator Combination Socket for VOLTAGE OUTPUT and CURRENT OUTPUT

The combination socket CURRENT OUTPUT / VOLTAGE OUTPUT simplifies the connection of test objects to the CMC 356. The three voltage outputs (VOLTAGE OUTPUT 1-3) as well as the CURRENT OUTPUT A are wired to the combination socket (refer to table 5-1 on page 31).

Figure 5-4:
Generator combination
socket



Front view

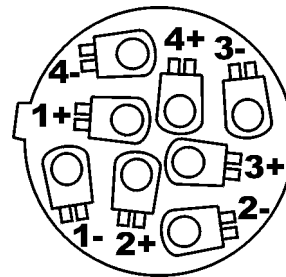

View onto the connector from
the cable wiring side

WARNING:



The connections on the socket are dangerous when the test set is turned on.

Follow the safety information provided at the beginning of this manual when connecting the generator combination sockets.

If a dangerous voltage (greater than 42 V) is applied to the socket, a warning indicator lights above the socket.

For currents greater than 25 A, the test object (load) should be exclusively connected to the 4 mm/0.16 " banana sockets and not on the generator connection socket.

Table 5-1:
Pin layout

Pin	Signal
1-	VOLTAGE N
2-	VOLTAGE 3
3-	VOLTAGE 2
4-	VOLTAGE 1
1+	CURRENT A 1
2+	CURRENT A N
3+	CURRENT A 3
4+	CURRENT A 2

Note: If using negative sequence phase rotation, swap the connectors VOLTAGE 2 and VOLTAGE 3 as well as CURRENT 2 and CURRENT 3.

Table 5-2:
Manufacturer ordering
information

Description of the generator combination socket	
Description	SPEAKON LINE 8-pole
Article Number	NL8FC
Manufacturer	Neutrik (www.neutrik.com)

You can order the plug for generator combination socket directly from OMICRON. For the part number refer to section 9.8, "Ordering Information" on page 127.

5.2 Connections on the Back Panel

Figure 5-5:
Rear view of CMC 356

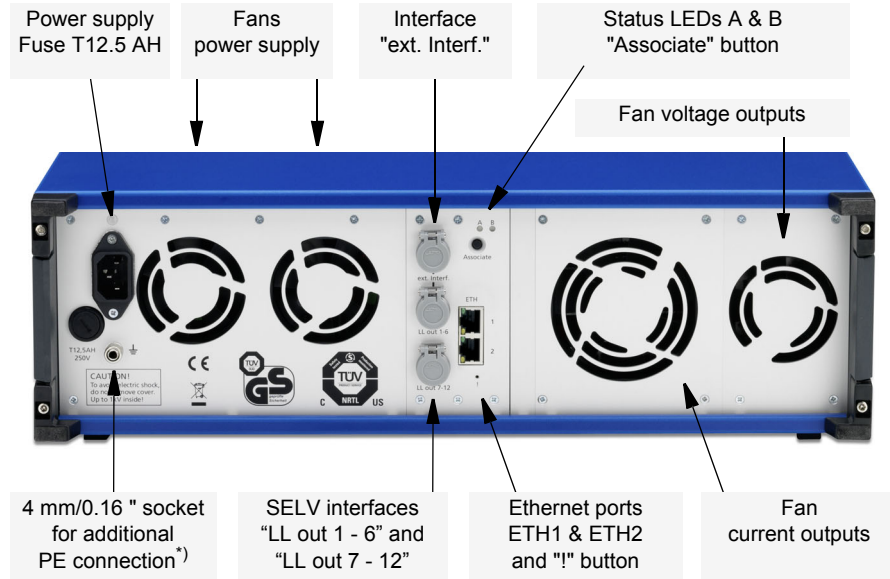

*) For example to connect to low resistance grounding bars.



The SELV interface LL out 7 - 12 is optional. Please refer to section 6.11, "Option LLO-2 (Low Level Outputs)" on page 90.

5.2.1 Ethernet Ports ETH1 and ETH2

The two PoE (**P**ower over **E**thernet) ports ETH1 and ETH2 are standard 10/100Base-TX (twisted pair) Ethernet ports. They support auto crossing (auto MDI/MDIX). This means you can use a standard cable or a cross-over Ethernet patch cable.

Note: If your Ethernet ports ETH1 and ETH2 look different, i.e., ETH2 is the connector version of Fast Ethernet over optical fiber, refer to chapter 6.5, "Technical Data of the Ethernet Ports" on page 63.

Since the CMC test set can be controlled over a network, any distance between the controlling computer and the test set is possible. This enables direct remote control of the CMC test set, e.g., for end-to-end testing.

The Ethernet ports also provide the basis for the processing of substation protocols according to the IEC 61850 standard. They allow flexible configurations, e.g., for separation of data traffic from different network segments or segregation of substation protocol data and test set control commands.

The green LED indicates a link connection to a PC or a network. The yellow LED indicates active traffic (receiving or transmitting) on the cable.



For detailed technical data about the Ethernet ports, please refer to section 6.5, "Technical Data of the Ethernet Ports" on page 63.

5.2.2 ! Button



The ! button enables you to recover from unsuccessful software image downloads or other emergency situations. To start a new software image download, press the ! button with a pointed tool or a paper clip while powering-up the CMC. In that case, the test set will not start as usual but wait for a new software image download.

5.2.3 Associate Button



The Associate button has the following functions:

- **Association with controlling computer**

An Ethernet communication port enables you to communicate with any CMC available on the network. This may lead to dangerous situations where a user accidentally connects to a device located on a desk of somebody else, emitting unsafe voltages and endangering the person working there.

To prevent such a situation, a special mechanism is integrated into the CMC test set that allows only “authorized” clients to control the test set. By using the **Associate** button, the test set is registered for use with a specific host computer.

The test set will issue voltages and currents only when it is associated to the client requesting this. The association process can be initiated by the *Test Set Association and Configuration* tool or by the *OMICRON Device Browser*. For more details about this process, refer to the Help of the according tool.

For the association the Ethernet hardware address (MAC) of the controlling computer is remembered. Consequently, if the network interface on the computer has changed, the CMC test set has to be associated whenever the MAC address changes.

- **Reset IP Configuration**

If the **Associate** button is pressed while powering up the CMC test set, the IP configuration of the network interfaces is reset to factory default, which is DHCP/AutoIP for both network interfaces. It may be necessary to reset the IP configuration in this way to recover from settings with conflicting static IP addresses.

5.2.4 Status LED A, B



The status LED A and B are of interest in case of troubleshooting.

A: yellow status LED

- A lit yellow LED indicates that the test set is ready to be controlled by a computer. The hardware checks in the test set are finished, and the test set is properly connected to a computer or a network.
- The LED is off when the test set is waiting for an "emergency software image download". This is the case when pressing the ! button while powering-up the CMC test set.

B: green LED

If the yellow LED A is off, the green LED B signals the following conditions:

- LED B blinks slowly:
CMC test set waits for the TFTP download (Trivial File Transfer Protocol) of a software image.
- LED B is lit:
The TFTP download of the software image is in progress.
- LED B blinks quickly:
The computer writes (e.g., the software image) to the flash memory of the CMC test set. Do not turn off the CMC test set as long as the writing is in progress.

5.2.5 Ethernet / Network Settings

General

The OMICRON *Test Universe* software running on the computer communicates with the CMC test set via a network connection. Therefore it is possible to either have the CMC directly connected to the computer's network plug by a cable or to have the CMC and the controlling computer connected to a computer network.

Both network ports can be used equally, and both network ports have link LEDs (green) and traffic LEDs (yellow flashing) to check the physical connectivity and proper cabling.

IP Configuration

For the CMC test set to communicate with the controlling computer and the OMICRON *Test Universe* software, TCP/IP is used. The IP parameters are set by either the *Test Set Association and Configuration* tool or the *OMICRON Device Browser*.

The CMC test set can either be set to static IP addresses or use DHCP (**D**ynamic **H**ost **C**onfiguration **P**rotocol) and AutoIP/APIPA (**A**utomatic **P**rivate **I**P **A**ddressing).

Additionally, there is a special DHCP server integrated in the CMC test set to serve IP addresses only for that computer the OMICRON *Test Universe* software is running on. Note that this will only take place when there is no DHCP server in the network. If there is DHCP server in the network, the DHCP feature of the CMC test set remains inactive.

If the IP settings conflict with IP settings of other devices in the network, it is possible to reset the test set to factory defaults (DHCP and AutoIP) by pressing the **Associate** button at the rear of the test set while powering up the test set.

Security / Firewall Settings

To automatically detect and set the IP configuration of CMC test sets in the network, IP-multicasting is used by the *Test Universe* software. Therefore, a firewall program has to be configured to allow for this communication. For the Microsoft Windows Firewall in Windows XP SP2 (or later) the configuration of the firewall is done automatically during installation of the OMICRON *Test Universe*.

The software component on the computer that automatically detects test sets on the network (OMFind.exe) requires an enabled inbound connection on port 4987 for UDP. For TCP communication, the software component on the computer that controls the test sets (CMEngAI.exe) requires an enabled outbound connection on port 2200.



More information about the Firewall configuration can be found in the FAQ section of the **Get Support** booklet (Technical Support for CMC Test Sets). This manual is available as PDF file on your hard disk after the installation of OMICRON *Test Universe*. Its name is **_Support Booklet.pdf**.

Network Troubleshooting



For instructions to help you to incorporate network-capable CMC test sets into a computer network, please refer to the manual **Network-based CMC Test Sets**. This manual is available as PDF file on your hard disk after the installation of OMICRON *Test Universe*. Its name is **Network-based test sets.pdf**.

To view the manuals, start the *Test Universe* Help from the *Start Page* or any test module and navigate to the table of contents entry **User Manuals** (at the beginning of the table of contents). Click **Read Me First**. In this topic you find direct links to both manuals. To open a manual, just click the link.

5.2.6 SELV Interfaces

All inputs and outputs to the SELV group (SELV = Safety Extra Low Voltage) reference to a common neutral that is internally connected to the protective earth (GND) of the housing.

5.2.6.1 External Interface ("ext. Interf.")

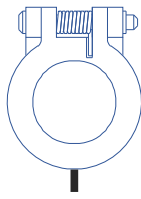

ext. Interf.

The SELV interface connector "ext. Interf." holds four additional transistor **binary outputs** (Bin. out 11 - 14). Unlike regular relay outputs, Bin. out 11 - 14 are bounce-free binary outputs (small signals) and have a minimal reaction time.

In addition, two high frequency **counter inputs** for up to 100 kHz are available for the testing of energy meters.

For more detailed information please refer to the technical data section 6.3.6, "Low-Level Binary Outputs ("ext. Interf.")" on page 54.

Meter Testing

For energy meter test applications, the "ext. Interf." permits easy connectivity. For more information about the connection of scanning heads please refer to sections 9.6.5, "Adapter Cable for Scanning Heads" on page 117 and 9.6.6, "CMLIB B" on page 118.

Synchronization

Via the "ext. Interf.", the *CMC 356* time base can be GPS- and IRIG-B-synchronized. Depending on the synchronization method of your choice, use either the *CMGPS* synchronization unit or the *CMIRIG-B* interface box.

Both synchronization accessories, the *CMGPS* and the *CMIRIG-B*, are optional and are described in more details in section 9.3, "Time Synchronization Accessories" on page 107.

5.2.6.2 LL out 1-6 (Low Level Outputs 1-6)

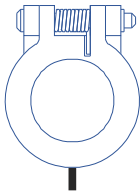

LL out 1 - 6

The SELV interface connector "LL out 1 - 6" holds two independent generator triples. These six high accuracy analog signal sources can serve to either control an external amplifier or to directly provide small signal outputs.

In addition, a serial digital interface is available that transmits control and monitor functions between the *CMC 356* and the external amplifiers. Supported devices are *CMA 156*, *CMA 56*¹, *CMS 156*, *CMS 251*¹ and *CMS 252*.

The low level outputs are short-circuit-proof and continually monitored for overload.

Connect the external amplifier to the *CMC 356* low level outputs. Use the connecting cable that was supplied with the amplifier.

For more detailed information please refer to the technical data section 6.3.5, "Low Level Outputs "LL out" for External Amplifiers" on page 52.

5.2.6.3 LL out 7-12 (Low Level Outputs 7-12) - Option "LLO-2"

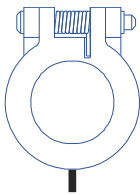

LL out 7 - 12

The SELV interface connector "LL out 7 - 12" is an option available for the *CMC 356* test set.

The outputs 7-12 extend the low level outputs 1-6 by two more independent generator triples. Outputs 7-12 are technically identical to outputs 1-6 as described above.

For more detailed information please refer to the technical data section 6.11, "Option LLO-2 (Low Level Outputs)" on page 90.

Overload Warning Flagged in the Software

When a low level output is overloaded, a corresponding warning message appears on the user interface of the *OMICRON Test Universe* software.

¹ These products are not available anymore.

6 TECHNICAL DATA

Guaranteed Values:

- General:
The values are valid for the period of one year after factory calibration, within $23\text{ °C} \pm 5\text{ °C}$ at nominal value and after a warm-up time greater than 25 min.
- Guaranteed values from the generator outputs:
The values are valid in the frequency range from 10 to 100 Hz unless specified otherwise. Given maximum phase errors are related to the voltage amplifier outputs.
- Accuracy data for analog outputs are valid in the frequency range from 0 to 100 Hz unless specified otherwise.
- The given input/output accuracy values relate to the range limit value (% of range limit value).

6.1 Main Power Supply

Table 6-1:
Power supply data

Main Power Supply	
Connection	Connector according to IEC 60320
Voltage, single phase nominal voltage operational range	100 - 240 V _{AC} 85 ... 264 V _{AC}
Power fuse	T 12.5 AH 250 V (5 x 20 mm) "Schurter", order number 0001.2515
Nominal current ¹	at < 170 V: 12 A max. at > 170 V: 10 A max.
Frequency nominal frequency operational range	50/60 Hz 45 ... 65 Hz
Overvoltage category	II

¹ Refer to section 6.3.4, "Operational Limits in Conjunction with Mains Supply" on page 51.

6.2 Insulation Coordination

Table 6-2:
Insulation coordination

Insulation Coordination	
Overvoltage category	II
Pollution degree	2 (except for Binary Inputs)
Insulation of function groups on front panel to ground (GND) ¹	<ul style="list-style-type: none"> - Basic insulation with maximum voltage of 600 V_{rms} to ground - Clearance: > 3 mm (0.12 ") - Creepage: > 6 mm (0.24 ") - Test voltage: 2200 V_{rms}
Insulation of functional groups on front panel from each other	<ul style="list-style-type: none"> - Working insulation - Clearance: > 1 mm (0.04 ") - Creepage: > 1 mm (0.04 ") - Test voltage: 1500 VDC
Measurement category (BINARY / ANALOG INPUTS)	<ul style="list-style-type: none"> - CAT III / 300 V_{rms} - CAT IV / 150 V_{rms}

¹ Functional groups on *CMC 356* front panel:
VOLTAGE OUTPUT, CURRENT OUTPUT (A, B), AUX DC, BINARY OUTPUT,
BINARY / ANALOG INPUT, ANALOG DC INPUT

6.3 Outputs

For block diagrams of the available generator outputs, please refer to section 4.1, "Block Diagram" on page 20.

Table 6-3:
Analog current, voltage,
and LL outputs.

General Generator Outputs Data (analog current and voltage outputs, outputs "LL out")	
Frequency ranges ¹ sinusoidal signals ² harmonics / interharmonics ³ transient signals	10 ... 1000 Hz 10 ... 3000 Hz DC ... 3.1 kHz
Frequency resolution	< 5 μ Hz
Frequency accuracy	\pm 0.5 ppm
Frequency drift	\pm 1 ppm
Bandwidth (-3 dB)	3.1 kHz
Phase range ϕ	- 360° to + 360°
Phase resolution	0.001°
Synchronized operation	Generator outputs can be synchronized to a reference input signal on binary/analog input 10 (range: 40 ... 70 Hz).
Temperature drift	0.0025 %/°C

¹ If you purchased the option **FL-6**, the maximum output frequency is constrained to **599 Hz**.

² Amplitude derating for current outputs at frequencies above 380 Hz.

³ Signals above 1 kHz are only supported in selected *Test Universe* modules and are only available on the voltage outputs and the low level outputs.

All voltages and current generators can independently be configured with respect to amplitude, phase angle, and frequency.

All outputs are monitored. Overload conditions result in a message displayed on the PC.

6.3.1 Extended Frequency Range

In selected *Test Universe* modules (e.g., *Harmonics* and *PQ Signal Generator*) the *CMC 356* supports a mode for generating stationary signals up to 3 kHz on the voltage outputs and the low-level outputs. This mode corrects the phase and gain errors of the output filter. The 3 dB bandwidth of this filter limits the amplitude at 3 kHz to about 70 % of the maximum range value. The application of the extended frequency range is the generation of harmonics and interharmonics.

Table 6-4:
Extended frequency range
(1 - 3 kHz)

Extended Frequency Range (1 - 3 kHz)		
	Typical	Guaranteed
Low Level Outputs ¹		
Phase error	< 0.25 °	< 1 °
Amplitude error	< 0.25 %	< 1 %
Voltage Amplifier		
Phase error	< 0.25 °	< 1 °
Amplitude error	< 0.25 %	< 1 %

¹ No extended frequency range support for external amplifiers.

6.3.2 Current Outputs

Table 6-5:
Outputs of current groups
A and B

Footnotes:

1. Data for three-phase systems are valid for symmetric conditions (0°, 120°, 240°) unless specified otherwise.
2. For wiring of single-phase modes see chapter 7, "Increasing the Output Power, Operating Modes" on page 91.
3. Single-phase mode (in phase opposition).
4. rd. = reading;
rg. = range, whereat n % of rg. means: n % of upper range value.
5. Valid for sinusoidal signals at 50/60 Hz and $R_{load} \leq 0.5 \Omega$.
6. Values at 20 kHz measurement bandwidth, nominal value, and nominal load.
7. Guaranteed data at 230 V mains for ohmic loads (PF=1); typical data for inductive loads. Refer to section 6.3.4, "Operational Limits in Conjunction with Mains Supply" on page 51.
8. For currents > 25 A, connect test object only to the 4 mm/0.16 " banana connections and not to the generator combination socket.
9. Current amplitude derating at frequencies above 380 Hz (see Figure 6-4).

Current Outputs ¹ (Groups A and B)		
Output currents		
6-phase AC (L-N)	6 x 0 ... 32 A (Group A and B)	
3-phase AC (L-N)	3 x 0 ... 64 A (Group A + B parallel)	
2-phase AC (L-L) ^{2, 3}	2 x 0 ... 32 A (Group A and B)	
1-phase AC (L-L) ^{2, 3}	1 x 0 ... 64 A (Group A + B parallel)	
1-phase AC (L-L-L-L) ^{2, 3}	1 x 0 ... 32 A (Group A + B in series)	
2-phase AC (LL-LN) ²	2 x 0 ... 64 A (Group A and B)	
1-phase AC (LL-LN) ²	1 x 0 ... 128 A (Group A + B parallel)	
DC (LL-LN) ²	1 x 0 ... ±180 A (Group A + B parallel)	
Power ⁷	Typical	Guaranteed
6-phase AC (L-N)	6 x 430 VA at 25 A	6 x 250 W at 20 A
3-phase AC (L-N)	3 x 860 VA at 50 A	3 x 500 W at 40 A
2-phase AC (L-L) ^{2, 3}	2 x 870 VA at 25 A	2 x 550 W at 20 A
1-phase AC (L-L) ^{2, 3}	1 x 1740 VA at 50 A	1 x 1100 W at 40 A
1-phase AC (L-L-L-L) ^{2, 3}	1 x 1740 VA at 25 A	1 x 1100 W at 20 A
2-phase AC (LL-LN) ²	2 x 500 VA at 40 A	2 x 350 W at 40 A
1-phase AC (LL-LN) ²	1 x 1000 VA at 80 A	1 x 700 W at 80 A
DC (LL-LN) ²	1 x 1400 W at ±80 A	1 x 1000 W at ±80 A
Accuracy	Typical	Guaranteed
$R_{load} \leq 0.5 \Omega$	Error < 0.05 % rd. ⁴ + 0.02% of rg.	Error < 0.15 % of rd. + 0.05% of rg.
$R_{load} > 0.5 \Omega$	Error < 0.1 % of rg.	Error < 0.3 % of rg.
Harmonic distortion (THD+N) ^{5,6}	0.05 %	< 0.15 %
Phase error ⁵	0.05 °	< 0.2 °
DC offset current	< 3 mA	< 10 mA
Resolution	1 mA, 2 mA (2 phases parallel), ...	
Frequency range ⁹	0 ... 1000 Hz	
Trigger on overload	Timer accuracy error < 1 ms	
Short-circuit protection	Unlimited	
Open-circuit protection	Open outputs (open-circuit) permitted	
Connection	4 mm/0.16 " banana connectors, amplifier connection socket ⁸ (OUTPUT A only)	
Insulation	Reinforced insulation of power supply and all SELV interfaces	

Figure 6-1:
Guaranteed output power per phase of a group and when groups A and B are connected in parallel (active power values in W are guaranteed; apparent power values in VA are typical values)

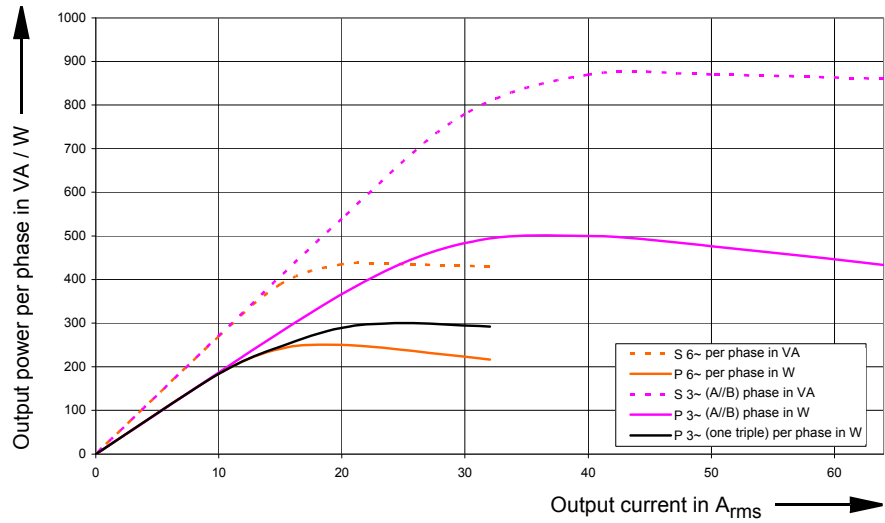
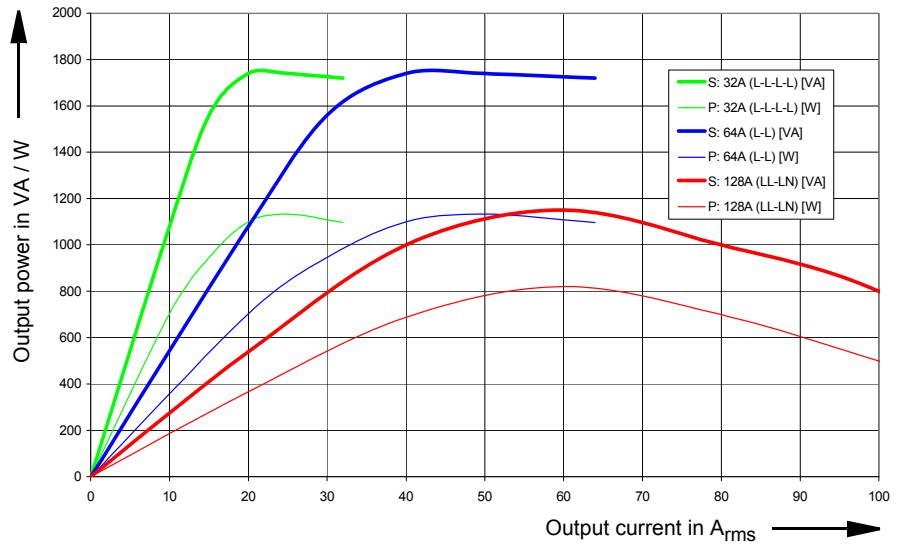
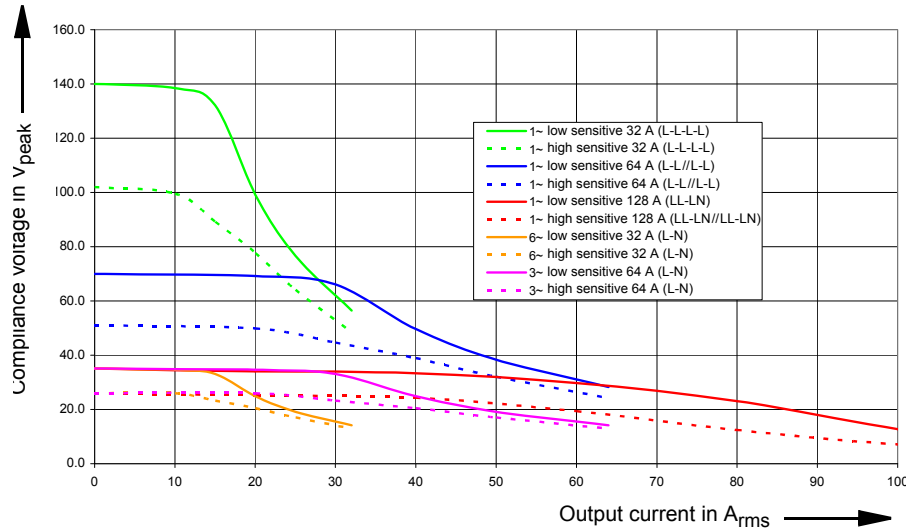

Figure 6-2:
Guaranteed single phase output power curves (active power values in W are guaranteed; apparent power values in VA are typical values)



For additional information refer to section 7.2, "Single-Phase Operation of the CMC 356" on page 92.

Figure 6-3:
Typical compliance
voltage (50/60 Hz)



The high and low sensitive curves in figure 6-3 correspond to the overload detection sensitivity settings in the *Test Universe* software. The low sensitive curves show the maximum available peak compliance voltage, which is mainly relevant for testing primary and electromechanical relays.

Figure 6-4:
Current derating at high
frequencies for sinusoidal
signals

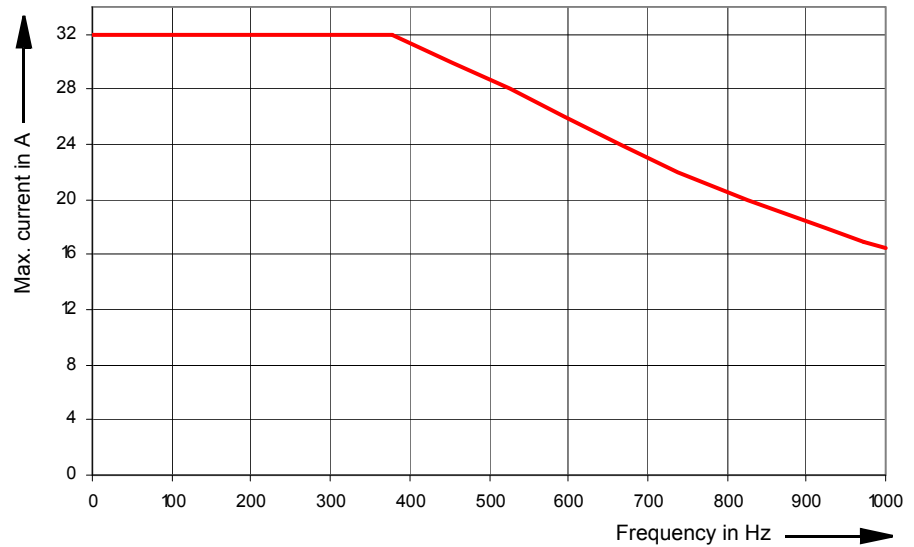

Figure 6-5:
Typical continuous output
current and output power
at 23 °C;
single-phase mode

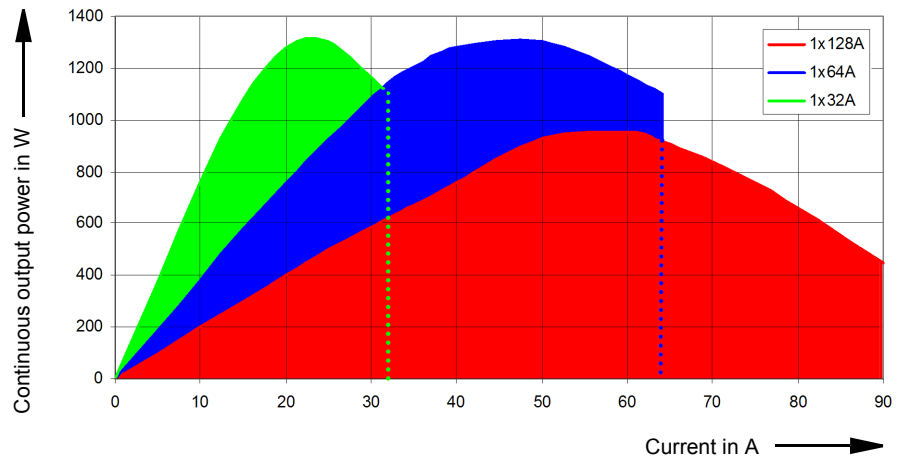
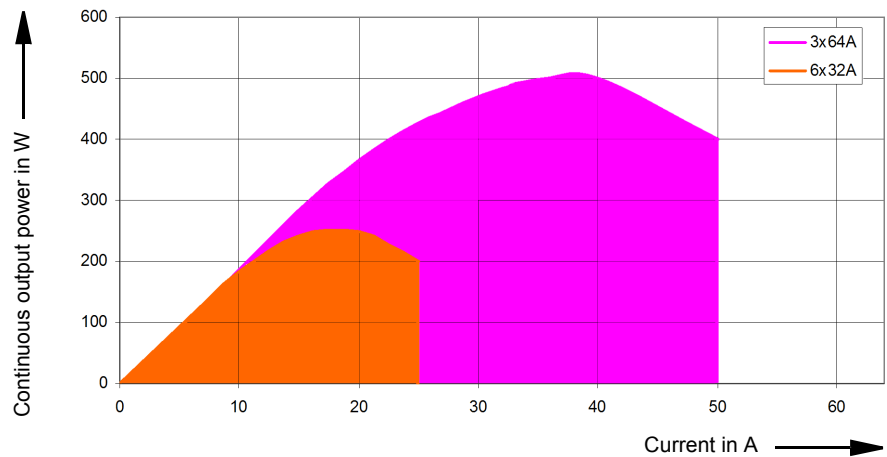

Figure 6-6:
Typical continuous output
current and output power
at 23 °C;
three- and six-phase mode



The continuous operating range is given by the area below the curves in the figure 6-5 and 6-6 above.

If you don't require more than 64 A, we recommend to use the 1 x 64 A configuration rather than the 128 A one because the 1 x 64 A configuration provides more continuous output power.

Due to the large number of operating modes, it is not possible to give universally applicable curves for the discontinuous mode. However, the examples given below can be used instead to gain feeling for the possible output durations (t_1 is the possible duration of a cold device).

Table 6-6:
Typical duty cycles for
operation at ambient
temperature of 23 °C

6 x 32 A (L-N)					
I [A]	P [W]	duty cycle	t1 [min]	ton [s]	toff [s]
0 ... 25	0 ... 1200	100%	> 30	> 1800	-
26	1400	80%	7.5	80	20
29	1300	75%	6.0	60	20
32	1200	71%	3.5	50	20

3 x 64 A (L-N)					
I [A]	P [W]	duty cycle	t1 [min]	ton [s]	toff [s]
0 ... 50	0 ... 1200	100%	> 30	> 1800	-
52	1400	80%	7.5	80	20
58	1300	75%	6.0	60	20
64	1200	71%	3.5	50	20

1 x 128 A (LL-LN)					
I [A]	P [W]	duty cycle	t1 [min]	ton [s]	toff [s]
0 ... 80	0 ... 700	100%	> 30.0	> 1800	0
100	450	60%	4.9	30	20
120	300	43%	2.6	15	20
128	200	38%	2.0	12	20

6.3.3 Voltage Outputs

Table 6-7:
CMC 356 voltage outputs

Footnotes:

- 1.a) V_{L4} (t) automatically calculated:
 $V_{L4}=(V_{L1}+ V_{L2}+ V_{L3}) * C$
C: configurable constant from -4 to +4.
- b) V_{L4} can be configured by software in frequency, phase, and amplitude.
2. Guaranteed data for ohmic loads, (PF=1). Refer to the accompanying figure of the output power curves. Refer to section 6.3.4, "Operational Limits in Conjunction with Mains Supply" on page 51.
- 3.Data for three-phase systems are valid for symmetric conditions (0°, 120°, 240°).
- 4.Data for four-phase systems are valid for symmetric conditions (0°, 90°, 180°, 270°).
- 5.rd. = reading;
rg. = range, whereat
n % of rg. means: n % of upper range value.
- 6.Valid for sinusoidal signals at 50/60 Hz.
7. 20 kHz measurement bandwidth, nominal value, and nominal load.
8. If you purchased the option **FL-6**, the maximum output frequency is constrained to **599 Hz**.

4 Voltage Outputs		
Output voltages		
3-phase AC (L-N)	3 x 0 ... 300 V	
4-phase AC (L-N) ¹	4 x 0 ... 300 V	
1-phase AC (L-N)	1 x 0 ... 300 V	
1-phase AC (L-L)	1 x 0 ... 600 V	
DC (L-N)	4 x 0 ... ± 300 V	
Output power ²	Typical	Guaranteed
3-phase AC ³	3 x 100 VA at 100 ... 300 V	3 x 85 VA at 85 ... 300 V
4-phase AC ⁴	4 x 75 VA at 100 ... 300 V	4 x 50 VA at 85 ... 300 V
1-phase AC (L-N)	1 x 200 VA at 100 ... 300 V	1 x 150 VA at 75 ... 300 V
1-phase AC (L-L)	1 x 275 VA at 200 ... 600 V	1 x 250 VA at 200 ... 600 V
DC (L-N)	1 x 420 W at 300 VDC	1 x 360 W at 300 VDC
Accuracy	Error < 0.03 % of rd. ⁵ + 0.01 % of rg.	Error < 0.08 % of rd. + 0.02 % of rg.
Harmonic distortion (THD+N) ^{6, 7}	0.015 %	< 0.05 %
Phase error ⁶	Typical 0.02 °	Guaranteed < 0.1 °
DC offset voltage	< 20 mV	< 100 mV
Voltage ranges	Range I: 0 ... 150 V Range II: 0 ... 300 V	
Resolution	Range I: 5 mV Range II: 10 mV	
Frequency ranges ⁸	Sinusoidal signals 10 ... 1000 Hz harmonics/interharm. ⁹ 10 ... 3000 Hz transient signals DC ... 3.1 kHz	
Short-circuit protect.	Unlimited for L - N	
Connection	4 mm/0.16 " banana connectors; amplifier connection socket V_{L1} - V_{L3}	
Insulation	Reinforced insulation of power supply and all SELV interfaces	

⁹ Signals above 1 kHz are only supported in selected software modules and are only available on the voltage outputs and the low level outputs.

6.3.3.1 Power Diagram for Three-Phase Operation

Figure 6-7:
Power diagram for
three-phase operation

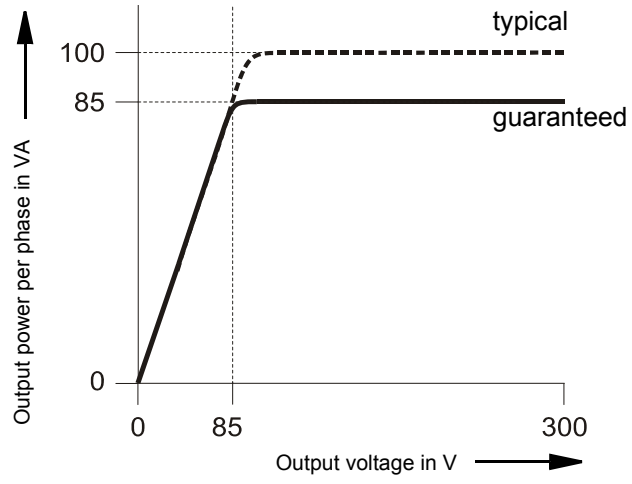

6.3.3.2 Power Diagram for Single-Phase Operation

Also refer to section 7.2.4, "Single-Phase Voltage" on page 95.

Figure 6-8:
Single-phase operation
L-N

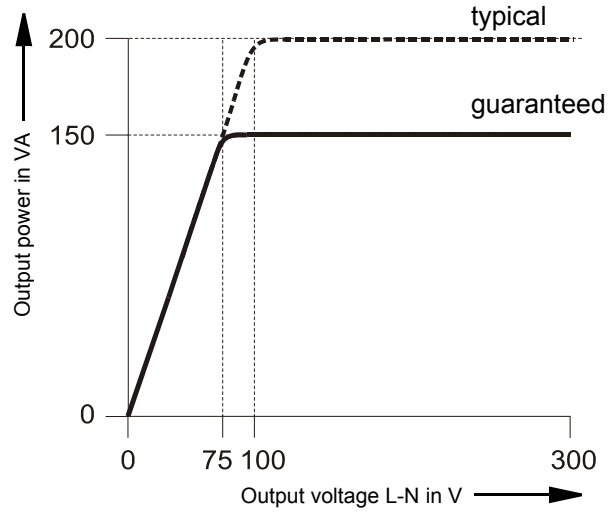
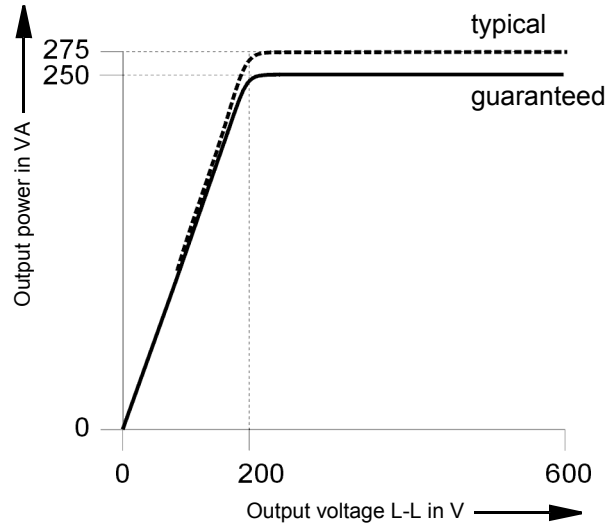

Figure 6-9:
Single-phase operation
L-L



6.3.4 Operational Limits in Conjunction with Mains Supply

Principally, the maximum output power of the *CMC 356* is limited by the mains input supply voltage.

For mains voltages of 115 V_{AC} or smaller, it is also possible to supply the *CMC 356* with two phases (L-L) instead of the normal phase-neutral (L-N) operation in order to increase the supply voltage (115 V * sqrt(3) = 200 V).

In order to limit the internal losses and to maximize the output power of the voltage amplifier, always set the maximum test object voltage to the minimum value possible for the test.

Beside the reduction of the available total output power of low line voltages, no other significant degradations in the technical data of the *CMC 356* occur.

Table 6-8:
Typical total output power
at different mains voltages.

Mains voltage	Current	Typical total output power		
		Currents only	Currents	AUX DC & voltage
230V	6 x 15 A	1600 W	1190 W + 300 W	
	6 x 25 A	1470 W	1060 W + 300 W	
	6 x 32 A	1320 W	910 W + 300 W	
115V ¹	6 x 15 A	1120 W	710 W + 300 W	
	6 x 25 A	990 W	580 W + 300 W	
	6 x 32 A	860 W	450 W + 300 W	
100V ¹	6 x 15 A	910 W	500 W + 300 W	
	6 x 25 A	790 W	380 W + 300 W	
	6 x 32 A	670 W	260 W + 300 W	

¹ After 15 min of continuous operation at full output power a duty cycle of 15 min on/15 min off is required at an ambient temperature of 25°C. This does not apply to the 6 x 32 A example because the output duration is limited by the current amplifier (see Chapter 6.3.2, "Current Outputs" on page 43 for more details).

6.3.5 Low Level Outputs "LL out" for External Amplifiers



Note: The low-level outputs "LL out 7 - 12" are only available, if the option *LLO-2* is installed, refer to section 6.11, "Option LLO-2 (Low Level Outputs)" on page 90.

Both SELV interface connectors "LL out 1 - 6" as well as the optional "LL out 7 - 12" (if applicable) hold two independent generator triples each. These six high accuracy analog signal sources per connector can serve to either control an external amplifier or to directly provide small signal outputs.

In addition, each SELV interface connector provides a serial digital interface (pins 8-16; see below) that transmits control and monitor functions between the *CMC 356* and the external amplifiers. Supported devices are the *CMA 156*, *CMA 56*, *CMS 156*, *CMS 251* and *CMS 252* (see also 9.6.7, "CMLIB A" on page 119 and 9.6.9, "Connection Cable for REF 54x Relays (ABB) with Low Level Signal Inputs" on page 121).

The low level outputs are short-circuit-proof and continually monitored for overload. They are separated through reinforced insulation from the power input and from the load outputs (SELV interface). They deliver calibrated signals in the range from 0 to 7 V_{eff} nominal (0 to $\pm 10 V_{peak}$).

Both the selection of the particular amplifier as well as the specification of the range of the amplifier takes place in the *Test Universe* software.

Figure 6-10:
Pin assignment of
"LL out 1-6" (lower 16-pole
Lemo socket); view onto
the connector from the
cable wiring side.

The pin assignment of
"LL out 7-12" socket is
identical.

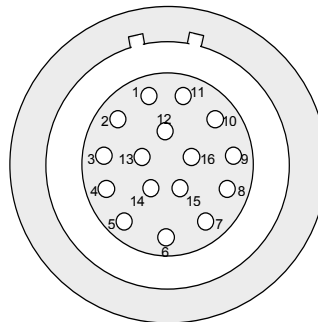

Pin	Function LL out 1-6	Function LL out 7-12
Pin 1	LL out 1	LL out 7
Pin 2	LL out 2	LL out 8
Pin 3	LL out 3	LL out 9
Pin 4	Neutral (N) connected to GND	
Pin 5	LL out 4	LL out 10
Pin 6	LL out 5	LL out 11
Pin 7	LL out 6	LL out 12
Pin 8-16	For internal purposes	
Housing	Screen connection	

"LL out 1-3" and "LL out 4-6" (and optionally "LL out 7-9" and "LL out 10-12") each make up a selectable voltage or current triple.

Table 6-9:
Data for SELV outputs
"LL out"

6 Outputs "LL out 1 - 6" and 6 (optional) outputs "LL out 7 - 12"		
Output voltage range	0...±10 V _{peak} ¹	
Frequency range ²	0 ... 3000 Hz	
Output current	Max. 1 mA	
Resolution	< 250 µV	
Accuracy	Typical < 0.025 %	Guaranteed < 0.07 % for 1...10 V _{peak}
Harmonic distortion (THD+N) ³	Typical < 0.015 %	Guaranteed < 0.05 %
Phase error ⁴	Typical 0.02 °	Guaranteed < 0.1 °
DC offset voltage	Typical < 150 µV	Guaranteed < 1.5 mV
Unconventional CT/VT simulation	Linear or Rogowski ⁵ mode	
Overload indication	Yes	
Short-circuit protection	Unlimited to GND	
Insulation	Reinforced insulation to all other potential groups of the test equipment. GND is connected to protective earth (PE).	

¹ Input OMICRON amplifier nominal: 0 ... 5 V_{rms}

² If you purchased the option **FL-6**, the maximum output frequency is constrained to **599 Hz**.

³ Values at nominal voltage (10 V_{peak}), 50/60 Hz, and 20 kHz measurement bandwidth.

⁴ Valid for sinusoidal signals at 50/60 Hz.

⁵ When simulating Rogowski sensors, the output voltage is proportional to the derivative of the current with respect to time (di(t)/dt).

Table 6-10:
Ordering Information

Ordering Information	
Connector for two guide notches and pull relief (for "LL out")	FGB.2B.316.CLAD 72Z
Black anti-bend cable cover	GMA.2B.070 DN

For a manufacturer description about the connection sockets "LL out" and "ext. Interf.", visit the Web site www.lemo.com.

6.3.6 Low-Level Binary Outputs ("ext. Interf.")

The SELV interface connector "ext. Interf." holds four additional transistor binary outputs (Bin. out 11 - 14). Unlike regular relay outputs, Bin. out 11 - 14 are bounce-free binary outputs (small signals) and have a minimal reaction time.

In addition, two high frequency counter inputs for up to 100 kHz are available for the testing of energy meters. They are described in section 6.4.2, "Counter Inputs 100 kHz (Low Level)" on page 61.

Figure 6-11:
Pin assignment of "ext. Interf." (upper 16-pole Lemo socket); view onto the connector from the cable wiring side

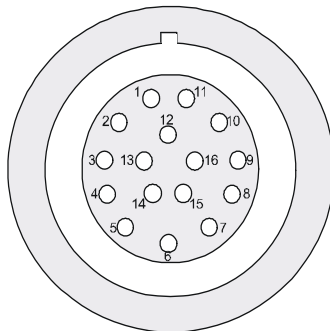

Pin	Function
Pin 1	Counter input 1
Pin 2	Counter input 2
Pin 3	Reserved
Pin 4	Neutral (N) connected to GND
Pin 5	Binary output 11
Pin 6	Binary output 12
Pin 7	Binary output 13
Pin 8	Binary output 14
Pin 9	Reserved
Housing	Screen connection

Table 6-11:
Data of the low-level binary outputs 11 - 14

4 Low-Level Transistor Binary Outputs (Bin. out 11 - 14)	
Type	Open-collector transistor outputs; external pull-up resistor
Switching voltage	Max. 15 V
Max. input voltage	±16 V
Switch current	Max. 5 mA (current limited); min. 100 µA
Actualization time	100 µs
Rise time	< 3 µs ($V_{\text{extern}} = 5 \text{ V}$, $R_{\text{pullup}} = 4.7 \text{ k}\Omega$)
Connection	Connector "ext. Interf." (CMC 356 rear side)
Insulation	Reinforced insulation to all other potential groups of the test equipment. GND is connected to protective earth (PE).

Figure 6-12:
Circuit diagram of
"ext. Interf." binary
transistor outputs 11 - 14

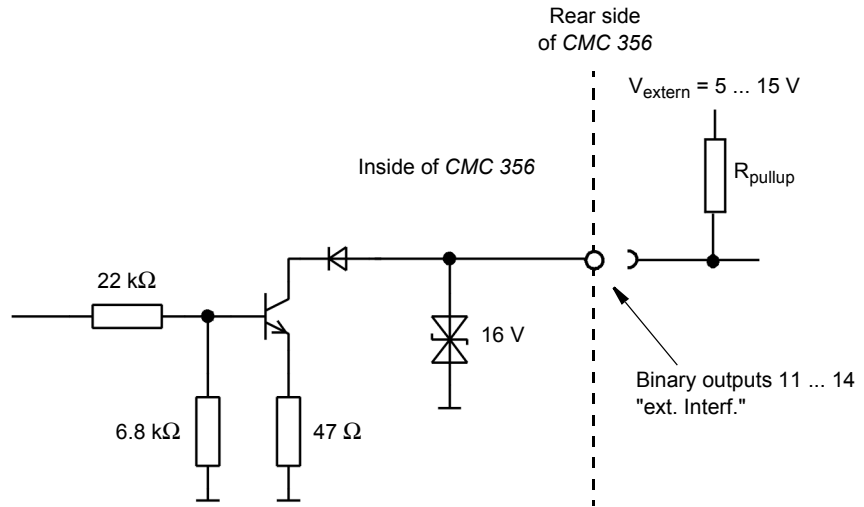

Table 6-12:
Ordering Information

Ordering Information	
Connector for one guide notch and pull relief (for "ext. Interf")	FGG.2B.316.CLAD 72Z
Black anti-bend cable cover	GMA.2B.070 DN

For a manufacturer description about the connection sockets "LL out" and "ext. Interf.", visit the Web site www.lemo.com.

6.3.7 Binary Output Relays

Table 6-13:
Data of binary output
relays

4 Binary Output Relays (Binary Outputs 1-4)	
Type	Potential-free contacts; software-controlled
AC loading	V_{max} 300 VAC; I_{max} 8 A; P_{max} 2000 VA
DC loading	V_{max} 300 VDC; I_{max} 8 A; P_{max} 50 W (refer to load limit curve)
Switch-on current	15 A (max. 4 s at 10 % duty-cycle)
Electrical lifetime	100 000 switching cycles at 230 V _{AC} / 8 A and ohmic load
Pickup time	Approx. 6 ms
Fall back time	Approx. 3 ms
Bounce time	Approx. 0.5 ms
Connection	4 mm/0.16 " banana sockets
Insulation	Reinforced insulation from all SELV interfaces and from power supply.

The accompanying diagram shows the load limit curve for DC voltages. For AC voltages, a maximum power of 2000 VA is achieved.

Figure 6-13:
Load limit curve for relays
on the binary outputs with
DC voltages

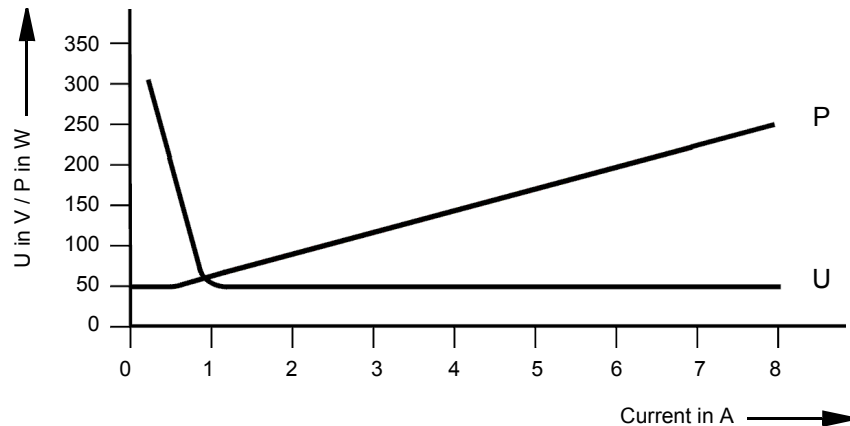

6.3.8 DC Supply (AUX DC)

Table 6-14:
DC Voltage supply
AUX DC

DC Supply (AUX DC)	
Voltage ranges	0 ... 66 V _{DC} (max. 0.8 A) 0 ... 132 V _{DC} (max 0.4 A) 0 ... 264 V _{DC} (max. 0.2 A)
Power	Max. 50 W
Accuracy ¹	Error: typical < 2 %, guaranteed < 5 %
Resolution	< 70 mV
Connection	4 mm/0.16 " banana sockets on front panel
Short-circuit protection	Yes
Overload indication	Yes
Insulation	Reinforced insulation from power supply and all SELV interfaces

¹ Percentage is with respect to each range's full-scale.

6.4 Inputs

6.4.1 Binary Inputs



Note: If option ELT-1 is installed, only the general binary input data given in the following Table 6-15 are valid. For detailed information about the option ELT-1, please refer to section 6.10, "Option ELT-1" on page 67.

Table 6-15:
General data of
binary inputs

General Data of Binary Inputs 1...10	
Number of binary inputs	10
Trigger criteria	Potential-free or DC-voltage compared to threshold voltage
Reaction time	Max. 220 μ s
Sampling frequency	10 kHz
Time resolution	100 μ s
Max. measuring time	Unlimited
Debounce time	0...25 ms (refer to page 60)
Deglintch time	0...25 ms (refer to page 60)
Counting function counter frequency pulse width	3 kHz (per input) >150 μ s (for high and low signals)
Configuration	Binary inputs can be configured. Refer to the OMICRON <i>Test Universe</i> Help.
Connection	4 mm/0.16 " banana sockets on the front panel
Insulation	5 galvanic insulated binary groups with each 2 inputs having its own GND. Operation insulation to the power outputs, DC inputs and between galvanically separated groups. Reinforced insulation from all SELV interfaces and from power supply.

Table 6-16:
Data for potential-sensing
operation

Data for Potential-Sensing Operation		
Threshold voltage data per input range	Setting range	Resolution
Range I Range II	0...20V >20...300V	50mV 500mV
Max. input voltage	CAT III/ / 300 V _{rms} CAT IV / 150 V _{rms}	
Threshold voltage accuracy ¹	5% of rd. + 0.5% of rg.	
Threshold voltage hysteresis	Range I: typ. 60 mV Range II: typ. 900 mV	
Input impedance ² Threshold 0...20V Threshold 20...300V	210 kΩ 135 kΩ	

¹ Applies to positive voltage signal edge; value shown in % of reading (rd.) + % of upper range value (rg.)

² Refer to figure 5-2, "Simplified circuit diagrams of binary inputs and outputs (CMC 356 standard, without option ELT-1 installed)" on page 28.

Table 6-17:
Data for potential-free
operation

Data for Potential-Free Operation ¹	
Trigger criteria	Logical 0: R > 100 kΩ Logical 1: R < 10 kΩ
Input impedance	216 kΩ

¹ Refer to figure 5-2, "Simplified circuit diagrams of binary inputs and outputs (CMC 356 standard, without option ELT-1 installed)" on page 28.

Deglitching input signals

In order to suppress short spurious pulses a deglitching algorithm could be configured. The deglitch process results in an additional dead time and introduces a signal delay. In order to be detected as a valid signal level, the level of an input signal must have a constant value at least during the deglitch time. The figure below illustrates the deglitch function.

Figure 6-14:
Signal curve, deglitching
input signals

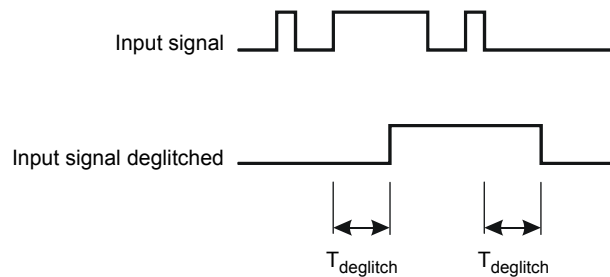

Debouncing input signals

For input signals with a bouncing characteristic, a debounce function can be configured. This means that the first change of the input signal causes the debounced input signal to be changed and then be kept on this signal value for the duration of the debounce time.

The debounce function is placed after the deglitch function described above and both are realized by the firmware of the *CMC 356* and are calculated in real time.

The figure below illustrates the deglitch function. On the right-hand side of the figure, the debounce time is too short. As a result, the debounced signal rises to “high” once again, even while the input signal is still bouncing and does not drop to low level until the expiry of another period $T_{debounce}$.

Figure 6-15:
Signal curve, debounce
input signals

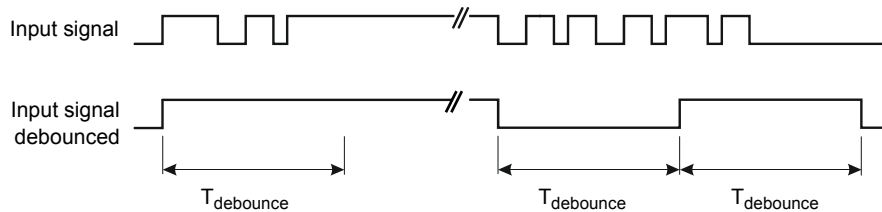

6.4.2 Counter Inputs 100 kHz (Low Level)

The SELV interface connector "ext. Interf." holds two high frequency counter inputs for up to 100 kHz are available for the testing of energy meters.

In addition, four transistor binary outputs (Bin. out 11 - 14) are available. They are described in section 6.3.6, "Low-Level Binary Outputs ("ext. Interf.")" on page 54.

Figure 6-16:
Pin assignment of "ext. Interf." (upper 16-pole Lemo socket); view onto the connector from the cable wiring side

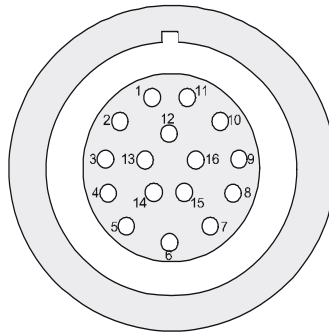

Pin	Function
Pin 1	Counter input 1
Pin 2	Counter input 2
Pin 3	Reserved
Pin 4	Neutral (N) connected to GND
Pin 5	Binary output 11
Pin 6	Binary output 12
Pin 7	Binary output 13
Pin 8	Binary output 14
Pin 9	Reserved
Housing	Screen connection

Table 6-18:
Counter inputs 100 kHz

2 Counter Inputs	
Max. counter frequency	100 kHz
Pulse width	> 3 μ s (high and low signal)
Switch threshold pos. edge neg. edge	max. 8 V min. 4 V
Hysteresis	typ. 2 V
Rise & fall times	< 1 ms
Max. input voltage	\pm 30 V
Connection	Socket "ext. Interf." (rear CMC 356)
Insulation	Reinforced insulation to all other potential groups of the test equipment. GND is connected to protective earth (PE).

Figure 6-17:
Circuit diagram of
"ext. Interf." counter inputs
1 and 2

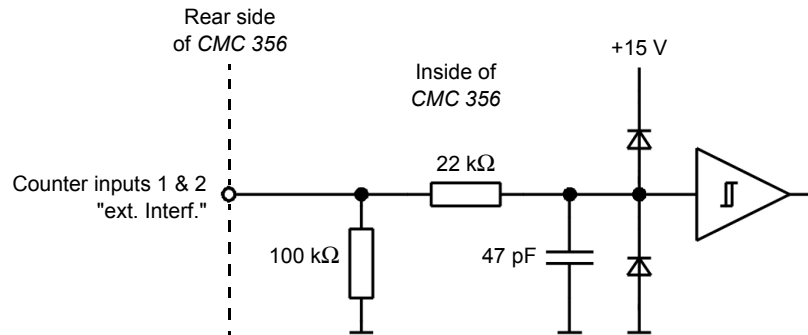

Table 6-19:
Ordering Information

Ordering Information	
Connector for one guide notch and pull relief (for "ext. Interf.")	FGG.2B.316.CLAD 72Z
Black anti-bend cable cover	GMA.2B.070 DN

For a manufacturer description about the connection sockets "LL out 1-6" and "ext. Interf.", visit the Web site www.lemo.com.

6.5 Technical Data of the Ethernet Ports

Originally, *CMC 356* test sets were delivered with a so-called NET-1 board that holds two different Ethernet ports:

ETH1: a 10/100Base-TX Ethernet port

ETH2: a 100Base-FX (optical fiber) Ethernet port.

With the introduction of the front panel control device **CMControl**, the *CMC 356* test sets are now equipped with a NET-1B board that holds two identical PoE (**P**ower **o**ver **E**thernet) ports ETH1 and ETH2.

CMC 356 test sets with NET-1 board can be upgraded with the new NET-1B board to be able to communicate with the new **CMControl** and have Ethernet access at the same time.

6.5.1 The NET-1B Board

Ethernet ports ETH1 and ETH2		
	Type	10/100Base-TX (10/100Mbit, twisted pair, auto-MDI/MDIX or auto-crossover)
	Connector	RJ45
	Cable type	LAN cable of category 5 (CAT5) or better
	Status indication	Green LED: physical link present Yellow LED: traffic on interface
	Power over Ethernet (PoE)	IEEE 802.3af compliant. Port capability limited to one Class 1 (3.84 W) and one Class 2 (6.49 W) power device.

6.5.2 The NET-1 Board

Table 6-20:
Technical data of the
NET-1 Ethernet port ETH1



Ethernet port ETH1		
	Type	10/100Base-TX (10/100Mbit, twisted pair, auto-MDI/MDIX or auto-crossover)
	Connector	RJ45
	Cable type	LAN cable of category 5 (CAT5) or better
	Status indication	Green LED: physical link present Yellow LED: traffic on interface

Table 6-21:
Technical data of the
NET-1 Ethernet port ETH2

Ethernet port ETH2		
	Type	100Base-FX (100Mbit, fiber, duplex)
	Connector	MT-RJ
	Cable type	50/125 μm or 62.5/125 μm (duplex patch cable)
	Cable length	> 1 km (0.62 miles) possible
	Status indication	Green LED: physical link present Yellow LED: traffic on interface
		This is a product of Laser Class 1 (IEC 60825)

6.6 Environmental Conditions

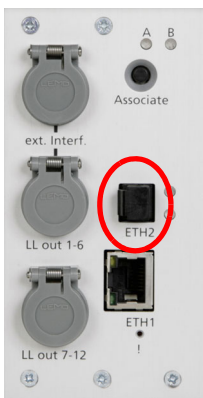
6.6.1 Climate

Table 6-22:
Climate

Climate	
Operating temperature	0 ... +50 °C; above +30 °C a 50 % duty cycle may apply.
Storage and transportation	-25 ... +70 °C
Max. altitude	2000 m
Humidity	5 ... 95% relative humidity; no condensation
Climate	Tested according to IEC 68-2-78

6.6.2 Shock and Vibration

Table 6-23:
Shock and vibration

Dynamics	
Vibration	Tested according to IEC 60068-2-6 (operating mode); frequency range 10 ... 150 Hz; acceleration 2 g continuous (20 m/s ²); 10 cycles per axis
Shock	Tested according to IEC 60068-2-27 (operating mode); 15 g / 11 ms, half-sinusoid, each axis

6.7 Mechanical Data

Table 6-24:
Data regarding size and weight





Size, Weight and Protection	
Weight	16.8 kg (37 lbs)
Dimensions W x H x D (without handle)	450 x 145 x 390 mm (17.7 x 5.7 x 15.4 ")
Housing	IP20 according to EN 60529

6.8 Cleaning

To clean the *CMC 356*, use a cloth dampened with isopropanol alcohol or water. Prior to cleaning, always switch off the power switch and unplug the power cord from the mains.

6.9 Safety Standards, Electromagnetic Compatibility (EMC) and Certificates

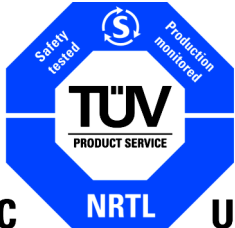
Table 6-25:
CE conformity, certified
Safety Standards and
EMC-compatibility

CE Conformity, Requirements	
The product adheres to the specifications of the guidelines of the council of the European Community for meeting the requirements of the member states regarding the electromagnetic compatibility (EMC) Directive 89/336/EEC and the low voltage Directive 73/23/EEC.	
EMC	
Emission	
Europe	EN 61326; EN 61000-6-4; EN 61000-3-2/3
International	IEC 61326; IEC 61000-6-4; IEC 61000-3-2/3
USA	FCC Subpart B of Part 15 Class A
Immunity	
Europe	EN 61326; EN 61000-6-2; EN 61000-4-2/3/4/5/6/11
International	IEC 61326; IEC 61000-6-2; IEC 61000-4-2/3/4/5/6/11
Certified Safety Standards	
Europe	EN 61010-1 Insulation of PC and SELV interfaces complies with EN 60950-1
International	IEC 61010-1
USA	UL 61010-1
Canada	CAN/CSA-C22.2 No 61010-1-04
Certificate	   
Manufactured under an ISO9001 registered system	

6.10 Option ELT-1

Figure 6-18:
Binary/analog inputs and
inputs for analog DC
measurement

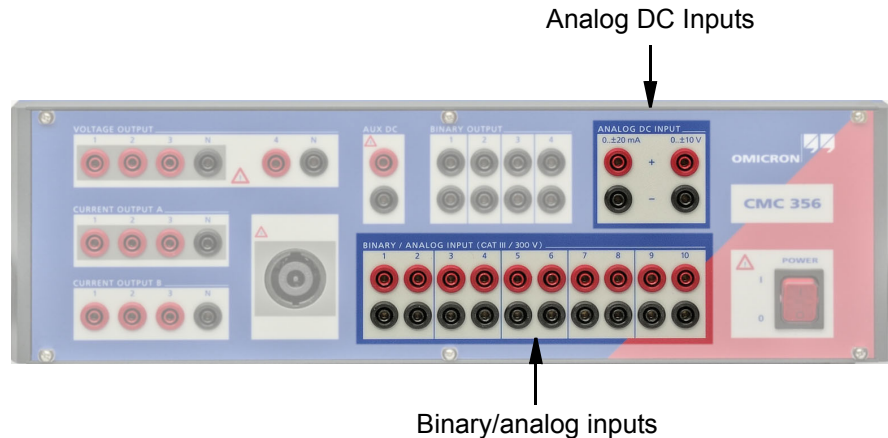

The ELT-1 option enables the *CMC 356* to measure analog signals:

- Analog DC inputs ($\pm 10\text{V}$ and either $\pm 1\text{mA}$ or $\pm 20\text{mA}$) for basic transducer testing with the test module *QuickCMC*.
- Basic voltage and current measurements with up to three of the 10 analog measurement inputs (restricted *EnerLyzer* mode).

In addition, the *Test Universe* module *EnerLyzer* provides the following functionality:

- Simultaneous measurement of up to 10 voltages and/or currents.
- Evaluation of DC components (DC voltages or DC currents).
- Real-time indication of effective values (true RMS) for all measurement signals.
- Peak values indication (U_{peak} , I_{peak} , ...).
- Phase angles with reference to a given input signal.
- Real-time calculation of apparent, reactive, and active power (in any configuration).
- Frequency and spectrum indication (harmonic diagrams) of periodic signals.
- Capturing of transient input signals with different sampling rates.
- Different triggering options for transient signal capturing (basic triggers and power quality triggers).
- Trend Recording: Measurement of RMS current, RMS voltage, frequency, phase, active, apparent and reactive power and power factor over long periods of time (up to 4 million samples possible).

Using the *CMC 356* test set in combination with the *Test Universe* module *Transducer* enables advanced testing of multifunctional single-phase and three-phase electrical transducers with symmetrical or non-symmetrical operating characteristics.

The hardware option ELT-1 can either be ordered with the new test set or later as a factory upgrade (the *CMC 356* needs to be returned to OMICRON).

6.10.1 General Data

The actual capturing of the measurement values and the range switching for the channels takes place in the analog input stages AFE (**A**nalog **F**ront **E**nd). Each AFE is used by two input channels and galvanically separated from the other input stages.

The measured values are passed through an isolation amplifier to the "Measurement Unit" and digitized by an A/D converter. The further processing is done by a high-performance floating point digital signal processor (DSP).

As such, apparent power, reactive power, active power, etc., can be provided in real-time and transmitted to the PC.

The analog measurement inputs have five measurement ranges that can be configured individually in the test module *EnerLyzer*.

- 100 mV
- 1 V
- 10 V
- 100 V
- 600 V

These range limits refer to the respective rms values of sinusoidal input signals. The ranges 100 mV, 1 V, 10 V and 100 V can be overloaded approximately with 10 %.

Input impedance: 500 kOhm || 50 pF for all measurement ranges.

Overload protection: 600 Vrms (± 850 Vpeak) from reference potential N, from another input, or protective earth (GND).

The sampling rate can be configured by software:

- 28.44 kHz
- 9.48 kHz
- 3.16 kHz

Four different operating modes are possible:

- Multimeter Mode (section 6.10.6)
- Harmonic Analysis (section 6.10.7)
- Transient Recording (section 6.10.8)
- Trend Recording (section 6.10.9)

6.10.2 Analog DC Input (V_{DC} , I_{DC})

Figure 6-19:
DC measurement unit
(analog inputs V_{DC} , I_{DC})

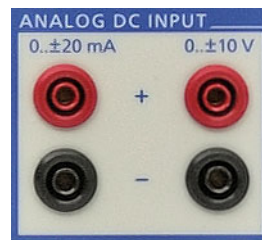

The measurement of analog DC signals has been implemented to enable the testing of transducers. The measurement unit consists of

- a highly accurate voltage reference,
- one ADC (**A**nalog **D**igital **C**onverter) for each input, and
- the respective input circuits (i.e., accurate voltage divider, shunt, filter).

The DC measurement unit measures the input signals V_{DC} and I_{DC} and performs the evaluation and forwarding of the measurement values.

Input I_{DC} has two measurement ranges: $0 \dots \pm 20 \text{ mA}$ and $0 \dots \pm 1 \text{ mA}$. The input is protected by a reversible input fuse. The inputs V_{DC} and I_{DC} reference a common neutral N. The DC measurement unit is galvanically isolated from all other connections on the front panel.

6.10.3 Accuracy of the Analog DC Input

Note: Exceeding the specified input values can damage the measurement inputs!

Table 6-26:
DC measurement input

DC Measurement Input IDC		
Measurement ranges	0 ... ±1 mA 0 ... ±20 mA	
Max. input current	600 mA	
Accuracy	Typical error < 0.003 % of rg. ¹	Guaranteed error < 0.02 % of rg.
Input impedance	Approx. 15 Ω	
Connection	4 mm/0.16 " banana connectors	
Insulation	Insulation to all other front panel connections. Reinforced insulation from all SELV interfaces and from power supply. Not galvanically isolated from V _{DC} .	

¹ rg. = range, whereat *n* % of rg. means: *n* % of upper range value.

Table 6-27:
DC voltage measurement input

DC Voltage Measurement Input VDC		
Measurement range	0...± 10 V	
Max. input voltage	± 11 V	
Input impedance	1 MΩ	
Max. input current	± 90 mA	
Accuracy	Typical error < 0.003 % of rg.	Guaranteed error < 0.02 % of rg.
Connection	4 mm/0.16 " banana connectors	
Insulation	Not galvanically isolated from I _{DC}	

6.10.4 Measuring Currents

Since the analog inputs of the *CMC 356* are voltage inputs, current measurement has to be performed using suitable active current clamps with voltage outputs or shunt resistors.

OMICRON offers the *C-PROBE1* as a suitable current clamp (refer to section 9.5, "Current Clamp C-PROBE1" on page 112). The *C-PROBE1* is not included in the scope of delivery of option ELT-1 and thus has to be ordered separately.

For further information, please contact OMICRON electronics (refer to section "Contact Information / Technical Support" on page 137).

6.10.5 Accuracy of Binary/Analog Inputs with Option ELT-1

The technical data for the binary inputs change with the installation of option ELT-1.

Figure 6-20:
Simplified diagrams of
analog and binary inputs
with option ELT-1 installed

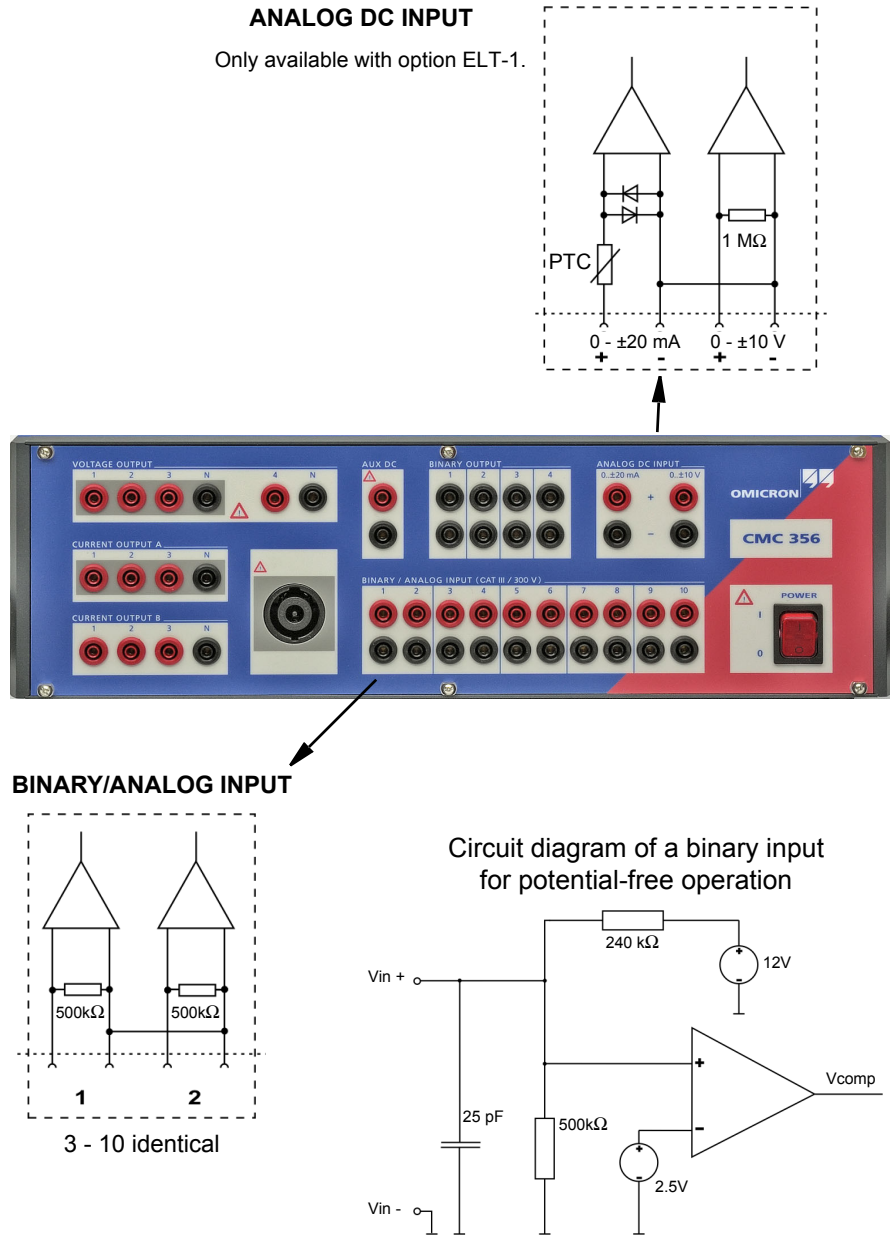

Table 6-28:
Data for potential-sensing
operation

Data for Potential-Sensing Operation		
Threshold voltage data per input range	Setting range	Resolution
100 mV	± 140 mV	2 mV
1 V	± 1.4 V	20 mV
10 V	± 14 V	200 mV
100 V	± 140 V	2 V
600 V	± 600 V	20 V
Max. input voltage	CAT II / 600 V _{rms} (850 V _{pk}) CAT III/ / 300 V _{rms} CAT IV / 150 V _{rms}	
Threshold voltage accuracy ¹ per range: 100 mV, 1 V, 10 V, 100 V, 600 V	Error: typical < 2 %, guaranteed < 4 % typical < 5 %, guaranteed < 10 %	
Threshold voltage hysteresis	1...5 % of the specified input in reference to each range's full-scale	
Input impedance	500 kΩ (50 pF)	

¹ Valid for positive voltage signal edge; percentage is shown in respect to each range's full-scale.

Table 6-29:
Data for potential-free
operation

Data for Potential-Free Operation ¹	
Trigger criteria	Logical 0: R > 80 kΩ Logical 1: R < 40 kΩ
Input impedance	162 kΩ (50 pF)

¹ Refer to figure 5-2, "Simplified circuit diagrams of binary inputs and outputs (CMC 356 standard, without option ELT-1 installed)" on page 28.

6.10.6 Multimeter Mode

This operating mode is designed for measuring steady-state signals (e.g., also non-sinusoidal shaped signals). Measurements such as rms values, phase angle, frequency, etc. can be performed.

The input signals are processed in real time without delay.

6.10.6.1 Accuracy of AC Measurements

Conditions: integration time 1 s, measurement signal sinusoidal, excitation 10 - 100 %, accuracy references the measurement full scale values.

Table 6-30:
Sampling rate 28.44 kHz;
measurement range
600 V, 100 V, 10 V, 1 V

Frequency range	Accuracy	
	Typical	Guaranteed
DC	± 0.15%	± 0.40%
10 Hz ... 100 Hz	± 0.06%	± 0.15%
10 Hz ... 1 kHz	+ 0.06% / -0.11%	± 0.25%
10 Hz ... 10 kHz	+ 0.06% / -0.7%	± 1.1%

Table 6-31:
Sampling rate 28.44 kHz;
measurement range
100 mV

Frequency range	Accuracy	
	Typical	Guaranteed
DC	± 0.15%	± 0.45%
10 Hz ... 100 Hz	± 0.1%	± 0.3%
10 Hz ... 1 kHz	+ 0.15% / -0.2%	± 0.5%
10 Hz ... 10 kHz	+ 0.15% / -1.0%	± 2%

Table 6-32:
Sampling rate
9.48 kHz
3.16 kHz;
measurement range
600 V, 100 V, 10 V, 1 V

Frequency range	Accuracy	
	Typical	Guaranteed
DC	± 0.15%	± 0.45%
10 Hz ... 100 Hz	± 0.08%	± 0.2%
10 Hz ... 1 kHz	+ 0.1% / -0.3%	± 0.5%
10 Hz ... 4 kHz (sampling rate 9.48 kHz)	+ 0.1% / -0.5%	± 1.2%
10 Hz ... 1.4 kHz (sampling rate 3.16 kHz)	+ 0.1% / -0.5%	± 1.0%

Table 6-33:
Sampling rate
9.48 kHz
3.16 kHz;
measurement range
100 mV

Frequency range	Accuracy	
	Typical	Guaranteed
DC	± 0.15%	± 0.5%
10 Hz ... 100 Hz	± 0.1%	± 0.35%
10 Hz ... 1 kHz	+ 0.15% / -0.35%	± 0.5%
10 Hz ... 4 kHz (sampling rate 9.48 kHz)	+ 0.15% / -0.6%	± 1.2%
10 Hz ... 1.4 kHz (sampling rate 3.16 kHz)	+ 0.15% / -0.6%	± 1.2%

The accuracy data contains linearity, temperature, long-term drift, and frequency.

Figure 6-21:
Typical frequency response with a sampling rate of 28.44 kHz and an input voltage of 70 V¹

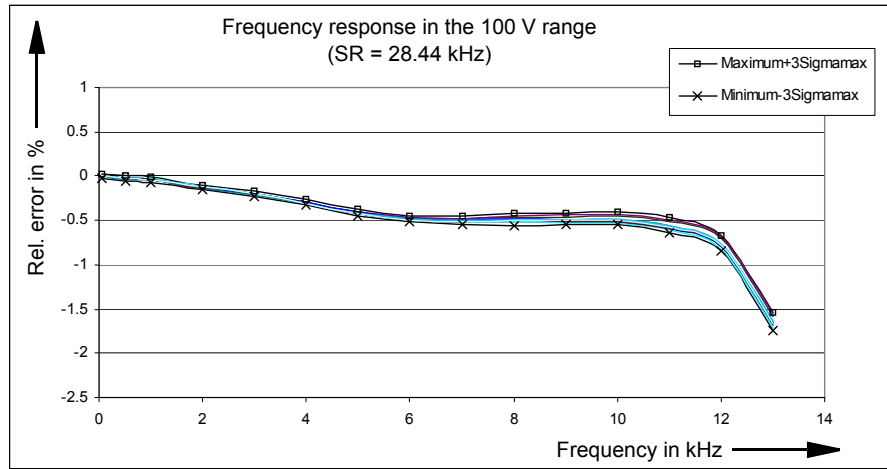
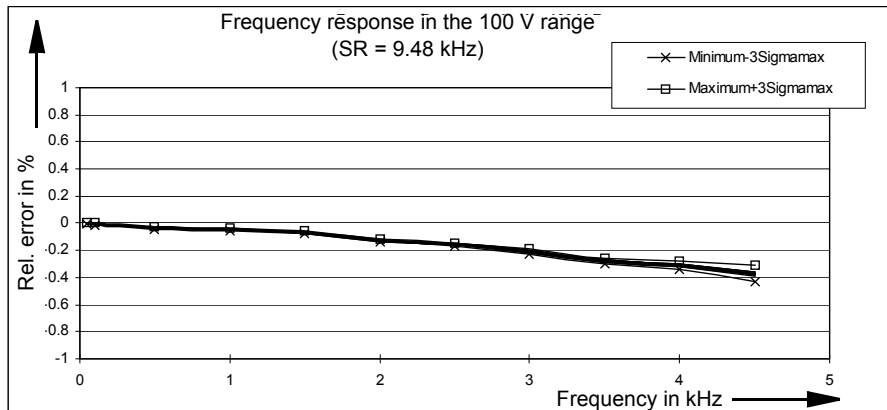

Figure 6-22:
Typical frequency response with a sampling rate of 9.48 kHz and an input voltage of 70 V¹



¹ a) Relative error: $\frac{\text{Actual} - \text{Expected}}{\text{Full scale}} \times 100 \%$

b) 3Sigma_{max} represents the maximum of the 3Sigma values of all 10 input channels. The 3Sigma_{max} value of an analog input are determined from 50 measurement values.

Figure 6-23:
Typical AC linear
progression at 50 Hz and a
sampling rate of
28.44 kHz¹

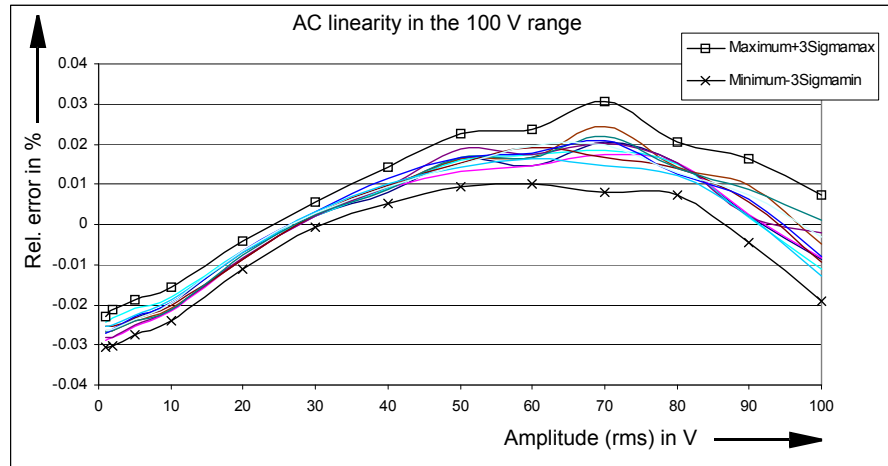

6.10.6.2 Channel Cross-Talk

Conditions: sinusoidal form infeed on a channel without overload, AC measurement on neighboring channel, integration time 1 s.

Table 6-34:
Cross talk dampening

Measurement range	600 V	100 V	10 V	1 V	100 mV
Dampening in dB	80	105	95	120	120

Cross talk dampening on channels of the same potential groups in dB at f = 50 Hz

Table 6-35:
Cross talk dampening

Measurement range	600 V	100 V	10 V	1 V	100 mV
Dampening in dB	65	80	75	95	95

Cross talk dampening on channels of the same potential groups in dB at f = 500 Hz

The cross-talk dampening on a neighboring channel of another potential group is greater than 120 dB in all measurement ranges (f = 50 Hz or 500 Hz).

$$^1 \text{ a) Relative error: } \frac{\text{Actual} - \text{Expected}}{\text{Full scale}} \times 100 \%$$

- b) $3\text{Sigma}_{\text{max}}$ represents the maximum of the 3Sigma values of all 10 input channels. The $3\text{Sigma}_{\text{max}}$ value of an analog input are determined from 50 measurement values.

6.10.6.3 Accuracy of Phase Measurement

Figure 6-24:
Phase error as function of
input voltage

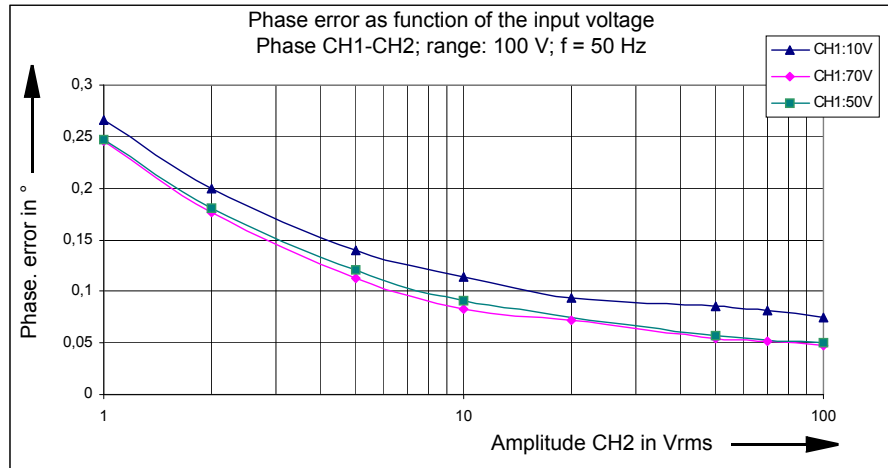

Conditions: integration time 1 s, measurement signal sinusoidal, measurement range 100 V, f = 50 Hz, sampling rate 28.44 kHz.

Figure 6-25:
Phase error as function of
sampling rate

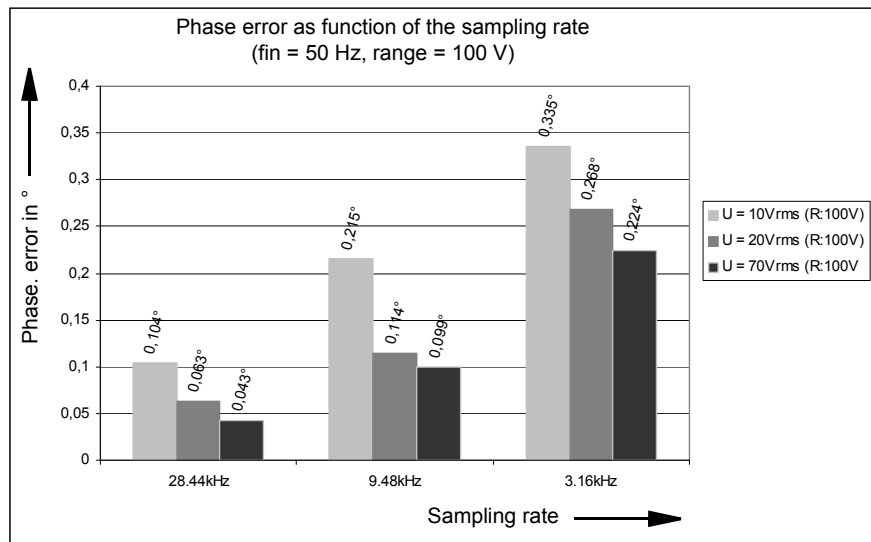

Conditions: integration time 1 s, measurement signal sinusoidal, f = 50 Hz, measurement range 100 V, both channels same excitation (20 V, 70 V).

Figure 6-26:
Typical phase error as
function of the input
frequency

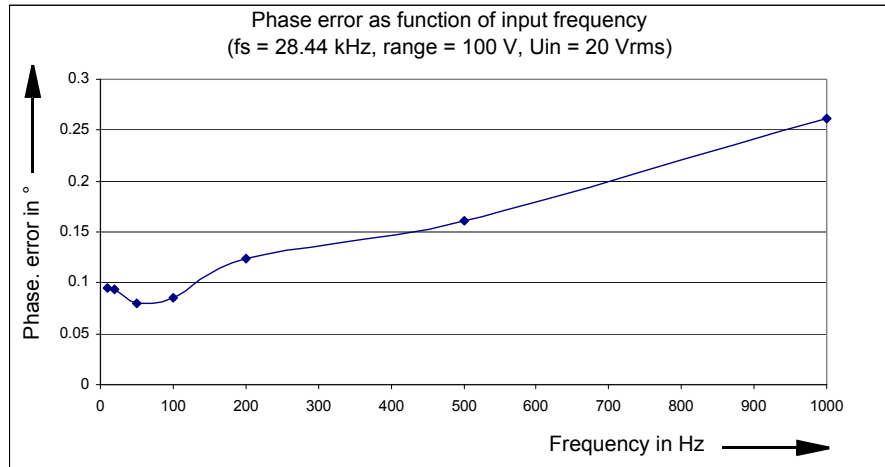

Conditions: integration time 1 s, measurement signal sinusoidal, sampling rate = 28.44 kHz, measurement range 100 V, excitation on both channels 20 Vrms.

The maximum input frequency for the phase measurement depends on the sampling rate.

Table 6-36:
Sampling rate and input
frequency range

Sampling rate	Input frequency range
28.44 kHz	10 Hz ... 2.30 kHz
9.48 kHz	10 Hz ... 750 Hz
3.16 kHz	10 Hz ... 250 Hz



Note:

1. The measurement accuracy of phase can be improved by:
 - increasing the integration time
 - enabling the recursive averaging function
2. When measuring very small phase shifts (less than 0.2 °), the sign (positive or negative) of the measurement results can not be definitely determined. If this causes a problem, please refer to the phase measurement in the harmonic analysis.
3. For measuring phase, the input voltage should be greater than 5 % of full scale. An overload of the measurement channel does not negatively affect the obtainable accuracy.

6.10.6.4 Accuracy of Frequency Measurement

Figure 6-27:
Error in the frequency measurement as a function of the input voltage

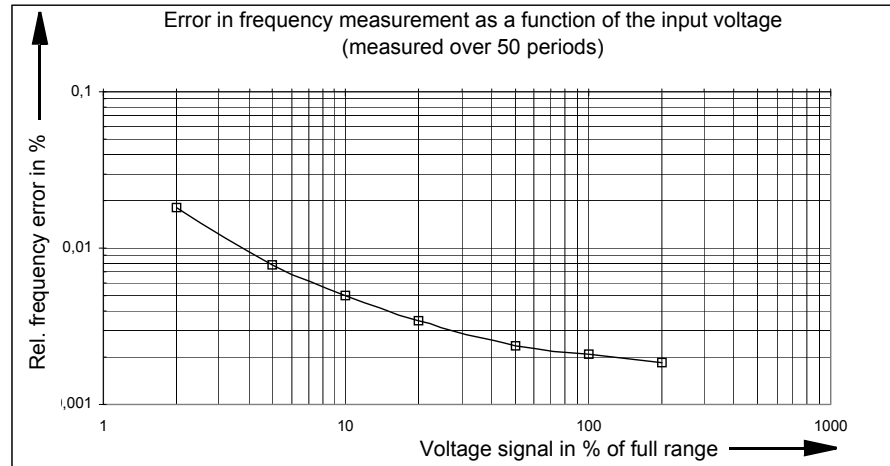

Conditions: integration time 1 s, measurement signal sinusoid.

The maximum input frequency for the frequency measurement depends on the sampling rate.

Table 6-37:
Sampling rate and input frequency range.

Sampling rate	Input frequency range
28.44 kHz	10 Hz ... 1500 Hz
9.48 kHz	5 Hz ... 500 Hz
3.16 kHz	5 Hz ... 150 Hz

Conditions: Excitation greater than 10 % from measurement full scale, duty cycle 50 %.



Note: With the harmonic analysis, input frequencies up to 3.4 kHz can be measured.

6.10.6.5 Accuracy of Power Measurement

General

The power is calculated from one current channel and one voltage channel:

$$\text{Active power: } P = \frac{1}{T} \int_0^T u(t) \cdot i(t) dt \text{ [W]}$$

$$\text{Apparent power: } S = V_{\text{rms}} \times I_{\text{rms}} \text{ [VA]}$$

$$\text{Reactive power: } Q = \sqrt{S^2 - P^2} \cdot \text{sign}_Q \text{ [var]}$$

$$U_{\text{rms}} = \sqrt{\frac{1}{T} \int_0^T u(t)^2 dt} \quad , \quad I_{\text{rms}} = \sqrt{\frac{1}{T} \int_0^T i(t)^2 dt}$$

Accuracies

Conditions: integration time 1s, measurement signal sinusoidal, excitation 10-100 %, accuracy references the apparent power, error of the current clamp is not taken into account.

Table 6-38:
Sampling rates
28.44kHz
9.48kHz
3.16kHz

Frequency range	Power	Accuracy ¹	
AC		Typical	Guaranteed
10 Hz ... 100 Hz	S	± 0.3 %	± 0.7 %
	P	± 0.3 %	± 0.7 %
	Q	± 0.8 %	± 2 %

Table 6-39:
Sampling rate
28.44kHz

Frequency range	Power	Accuracy ¹	
AC		Typical	Guaranteed
10 Hz ... 2.2 kHz	S	+ 0.3 % / - 1.2 %	± 2.5 %
	P	+ 0.3 % / - 1,2 %	± 2.5 %
	Q	+ 0.8 % / - 2.5 %	± 3.5 %

¹ Relative error: $\frac{\text{Actual} - \text{Expected}}{\text{Full scale}} \times 100 \%$

S = Apparent power
P = Active power
Q = Reactive power

Table 6-40:
Sampling rate
9.48 kHz

Frequency range	Power	Accuracy ¹	
		Typical	Guaranteed
AC			
10 Hz ... 750 Hz	S	+ 0.3 % / - 0.7 %	± 1.8 %
10 Hz ... 750 Hz	P	+ 0.3 % / - 0.7 %	± 1.8 %
10 Hz ... 750 Hz	Q	+ 0.8 % / - 1.2 %	± 2.5 %

Table 6-41:
Sampling rate
3.16 kHz

Frequency range	Power	Accuracy ¹	
		Typical	Guaranteed
AC			
10 Hz ... 250 Hz	S	+ 0.3 % / - 0.5 %	± 1.3 %
10 Hz ... 250 Hz	P	+ 0.3 % / - 0.5 %	± 1.3 %
10 Hz ... 250 Hz	Q	+ 0.8 % / - 1 %	± 2.2 %

Table 6-42:
DC accuracy

	Power	Accuracy ¹	
DC		Typical	Guaranteed
	P, S	± 0.3 %	± 0.9 %

$$^1 \text{ Relative error: } \frac{\text{Actual} - \text{Expected}}{\text{Full scale}} \times 100 \%$$

S = Apparent power
P = Active power
Q = Reactive power



Note: The accuracy specifications include linearity, temperature, ageing drift, frequency and phase response.

Typical relative error as function of the excitation

Figure 6-28:
 Typical error of the
 apparent power S as
 function of the excitation,
 $f_s = 28.44 \text{ kHz}$, $f_{in} = 50 \text{ Hz}$

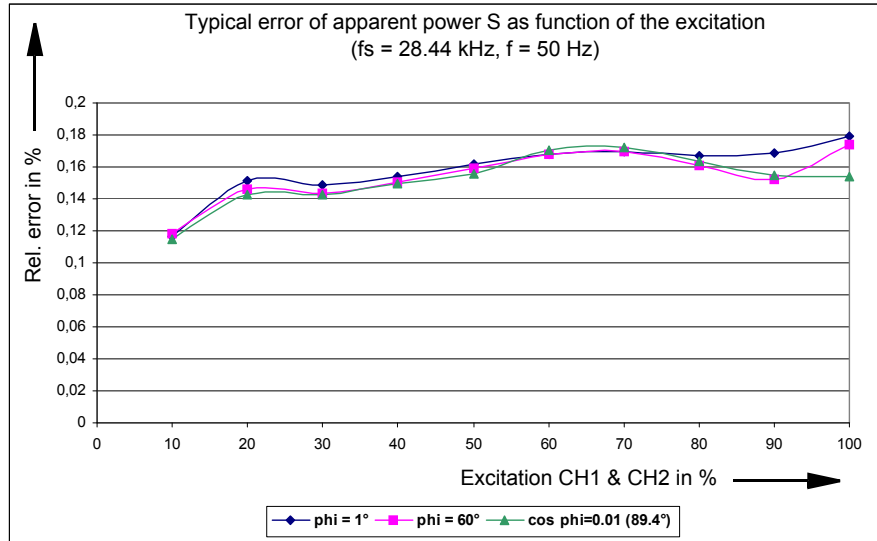

Figure 6-29:
 Typical error of the active
 power P as a function of
 the excitation considering
 the apparent power,
 $f_s = 28.44 \text{ kHz}$, $f_{in} = 50 \text{ Hz}$

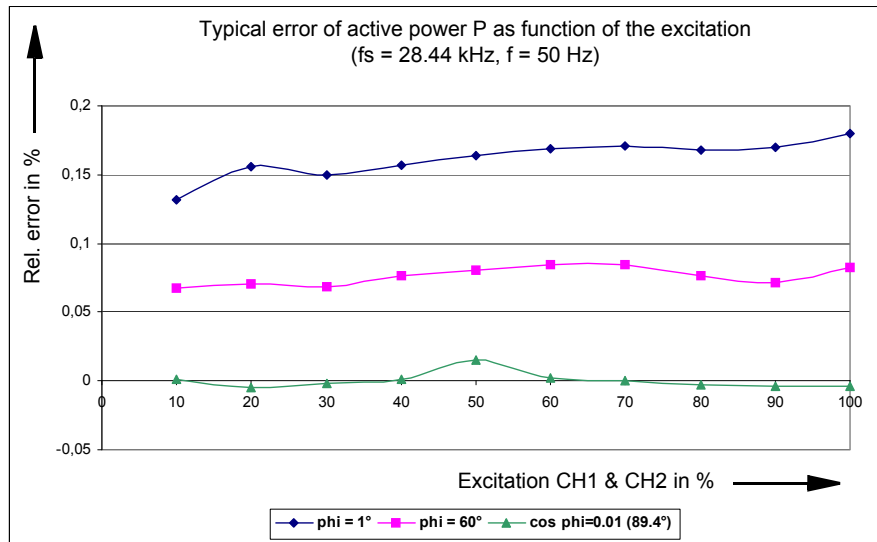
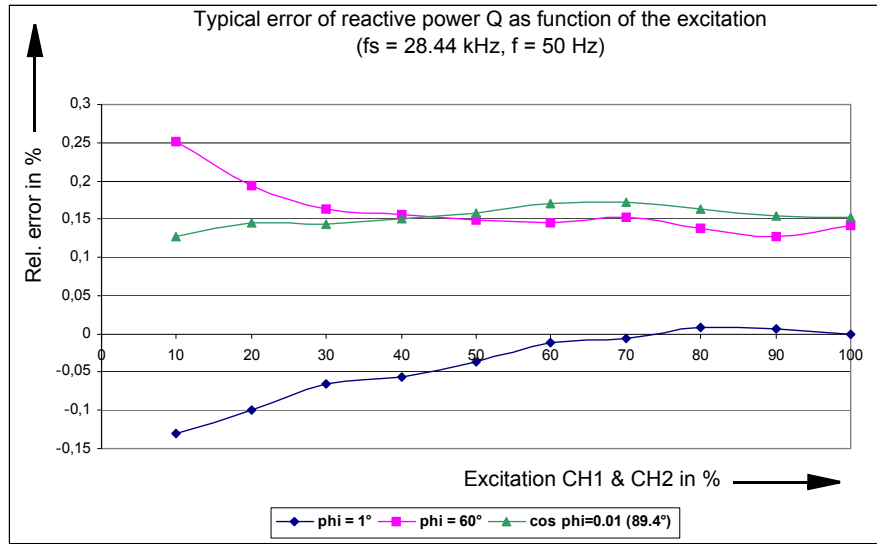
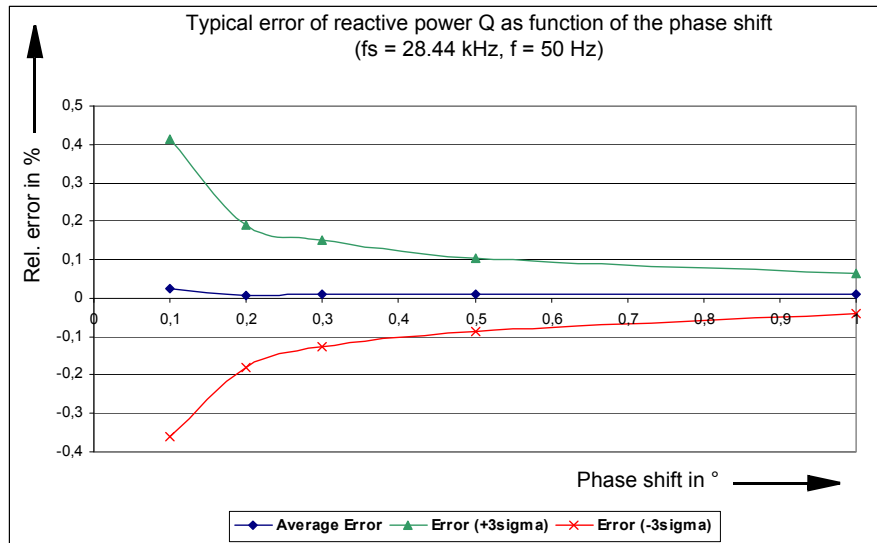

Figure 6-30:
Typical error of the reactive power Q as a function of the excitation, $f_s = 28.44 \text{ kHz}$, $f_{in} = 50 \text{ Hz}$



Conditions: integration time 1s, measurement signal sinusoid, sampling rate = 28.44 kHz, $f_{in} = 50 \text{ Hz}$

Figure 6-31:
Typical error¹ of the reactive power Q as a function of the phase shift considering the apparent power, $f_s = 28.44 \text{ kHz}$, $f_{in} = 50 \text{ Hz}$, excitation CH1 and CH2 = 70 %.



Conditions: integration time 1s, measurement signal sinusoidal, sampling rate = 28.44 kHz, both channels with same excitation 70 %

¹ The 3Sigma values are determined from 50 measurement values.

**Note:**

- For very small phase shifts ($< 0,3^\circ$) and small excitation ($< 10\%$), too small integration time ($< 1\text{ s}$) or sampling rate 3.16 kHz , the sign of the reactive power cannot definitely be determined.
- The accuracy of the power measurement depends primarily on the accuracy of the current clamp (refer to section 9.5, "Current Clamp C-PROBE1" on page 112).

6.10.7 Harmonic Analysis

This operating mode is designed for measuring stationary signals (e.g., not sinusoid shaped). The input signal is separated into fundamental and harmonic waves (Fourier Analysis).

The following items are measured:

- frequency of the fundamental wave
- amplitude of the fundamental and harmonic waves
- phase shifts between the fundamental and harmonic waves (also from the different channels)

The input signals are captured. Finally, the calculation of the measurement items is carried out. During this time, the input signal is not taken into consideration.

6.10.7.1 Accuracy of Frequency Measurement

The permitted input frequency range depends on the specified sampling rate:

Table 6-43:
Sampling rate and input frequency range

Sampling rate	Input frequency range
28.44 kHz	49 Hz ... 3400 Hz
9.48 kHz	17 Hz ... 1100 Hz
3.16 kHz	5 Hz ... 380 Hz

Figure 6-32:
Accuracy of frequency measurement as function of the voltage signal

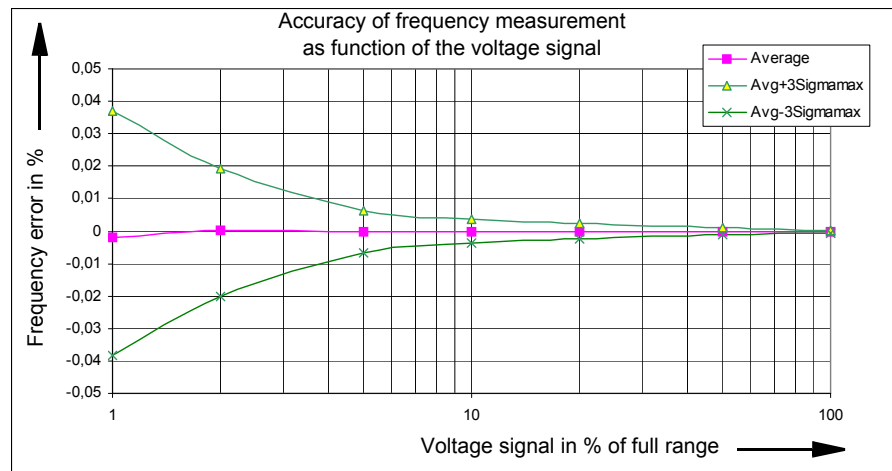

Conditions: sampling rate 9.48 kHz, f_{in} =20 Hz ... 1 kHz



Note: Through recursive averaging, the measurement uncertainty can be further reduced.

6.10.7.2 Accuracy of Amplitude Measurement

The measurement values are given as effective values (rms).

The permitted input frequency range for the fundamental wave depends on the specified sampling rate:

Table 6-44:
Sampling rate and input frequency range

Sampling rate	Input frequency range
28.44 kHz	100 Hz (= fmin) ... 3200 Hz
9.48 kHz	30 Hz (= fmin) ... 1000 Hz
3.6 kHz	10 Hz (= fmin) ... 350 Hz

Valid for fundamental and harmonic waves in specified frequency range; accuracy refers to full scale.

Table 6-45:
Sampling rate 28.44 kHz,
measurement range
600 V, 100 V, 10 V, 1 V

Frequency range	Accuracy	
	Typical	Guaranteed
fmin ... 1 kHz	± 0.1 %	± 0.3 %
fmin ... 10 kHz	+ 0.1 % / - 0.7 %	± 1.1 %

Table 6-46:
Sampling rate 28.44 kHz,
measurement range
100 mV

Frequency range	Accuracy	
	Typical	Guaranteed
fmin ... 1 kHz	± 0.2 %	± 0.5 %
fmin ... 10 kHz	+ 0.2 % / - 1.0 %	± 2.0 %

Table 6-47:
Sampling rate
9.48 kHz
3.16 kHz,
measurement range
600 V, 100 V, 10 V, 1 V

Frequency range	Accuracy	
	Typical	Guaranteed
fmin ... 100 Hz	± 0.1 %	± 0.3 %
fmin ... 1 kHz	+ 0.1 % / - 0.5 %	± 0.8 %
fmin ... 4 kHz (sampling rate = 9.48 kHz)	+ 0.1 % / - 0.8 %	± 1.2 %
fmin ... 1.4 kHz (sampling rate = 3.16 kHz)	+ 0.1 % / - 0.8 %	± 1.2 %

Table 6-48:
Sampling rate
9.48 kHz
3.16 kHz
measurement range
100 mV

Frequency range	Accuracy	
	Typical	Guaranteed
fmin ... 100 Hz	± 0.15 %	± 0.4 %
fmin ... 1 kHz	± 0.2 % / - 0.5 %	± 0.8 %
fmin ... 4 kHz (sampling rate = 9.48 kHz)	+ 0.2 % / - 1.0 %	± 1.5 %
fmin ... 1.4 kHz (sampling rate = 3.16 kHz)	+ 0.25 % / - 1.0 %	± 2.0 %

6.10.7.3 Accuracy of Phase Measurement

The permitted input frequency range for the fundamental wave depends on the specified sampling rate:

Table 6-49:
Sampling rate and input
frequency range

Sampling rate	Input frequency range
28.44 kHz	100 Hz ... 3200 Hz
9.48 kHz	30 Hz ... 1000 Hz
3.16 kHz	10 Hz ... 350 Hz

Table 6-50:
Accuracy of phase
measurement as function
of the excitation

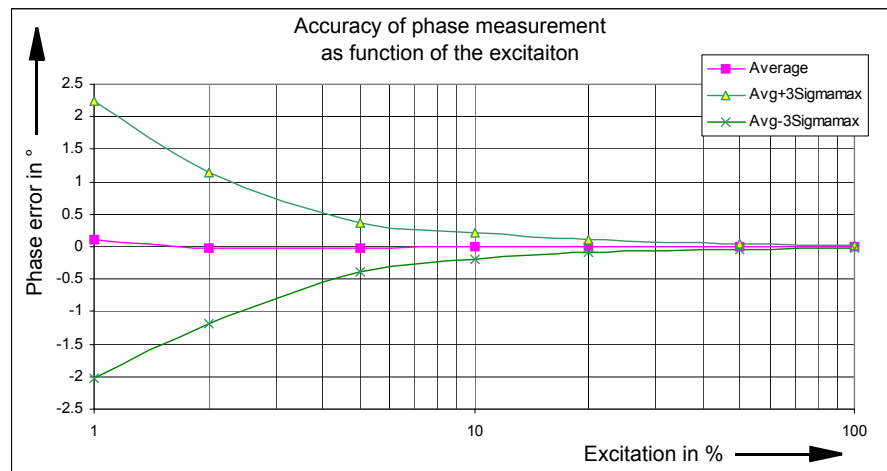

Conditions: sampling rate 9.48 kHz, $f_{in} = 50$ Hz.



Note: Through recursive averaging, the measurement uncertainty can be reduced further.

6.10.8 Transient Recording

In this operating mode, transient signals on up to 10 input channels can be recorded synchronously.

The recording starts whenever a pre-defined trigger condition is met. The selectable trigger conditions are:

- Trigger on threshold with positive or negative edge
- Combination of different power quality triggers (sag, swell, harmonic, frequency, frequency change, notch)

In addition, a time offset for the capture window relative to the trigger event can be specified. The trigger delay can be

- positive (recording begins after the trigger event)
- or negative (recording begins already before the trigger event).

Figure 6-33:
Illustration of the
relationship between
trigger events, trigger
delay, and recording time

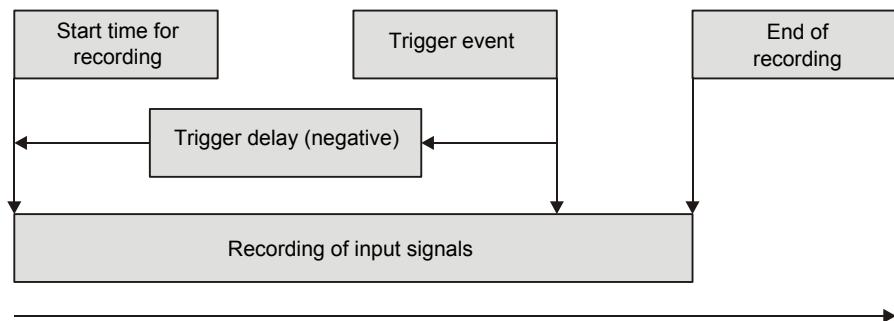

Note: More details about triggering methods can be found in the OMICRON *Test Universe* Help and in the practical examples of the ELT-1 option.

The maximum length of the recording depends on the settings for the sample rate and the number of channels to be captured.

Table 6-51:
The maximum recording time depends on the number of active channels and the sampling frequency

Number of active channels	Maximum recording time [s] at fs = 28.4 kHz	Maximum recording time [s] at fs = 9.48 kHz	Maximum recording time [s] at fs = 3.16 kHz
1	35.16 s	105.47 s	316.41 s
2	17.58 s	52.73 s	158.20 s
3	11.72 s	35.16 s	105.47 s
4	8.79 s	26.37 s	79.10 s
5	7.03 s	21.09 s	63.28 s
6	5.86 s	17.58 s	52.73 s
7	5.02 s	15.07 s	45.20 s
8	4.40 s	13.18 s	39.55 s
9	3.91 s	11.72 s	35.15 s
10	3.52 s	10.55 s	31.64 s
11 ¹	3.20 s	9.59 s	28.76 s

¹ All binary inputs are stored as one channel.

Accuracy of the sampling value:

- measurement ranges 600 V, 100 V, 10 V, 1 V:
± 0.2 % typical
± 0.5 % guaranteed
- measurement range 100 mV:
± 0.3 % typical
± 0.6 % guaranteed

The accuracy data are full scale errors.

6.10.9 Trend Recording

In Trend Recording Mode, you can make a historical plot of various measurements over time. It is possible to measure RMS voltage, RMS current, phase, real, apparent and reactive power and the power factor.

The main view has a CTS Chart. Each selected measurement function appears in a separate diagram (i.e. all frequency measurements in the frequency diagram). RMS current and voltage appear in separate diagrams. Time is displayed in seconds on the x-axis. The diagram is scrolled from right-to-left as new data is recorded.

6.11 Option LLO-2 (Low Level Outputs)

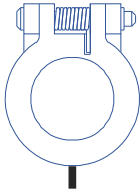

LL out 7 - 12

The *LLO-2* option ("LL out 7 - 12") represents an additional SELV (SELV = Safety Extra Low Voltage) interface connector holding two independent generator triples. These six high accuracy analog signal sources can serve to either control an external amplifier or to directly provide small signal outputs.

The outputs 7-12 extend the low level outputs 1-6 ("LL out 1-6") by two more independent generator triples. Outputs 7-12 are technically identical to outputs 1-6.

For more information please refer section 6.3.5, "Low Level Outputs "LL out" for External Amplifiers" on page 52.

7 INCREASING THE OUTPUT POWER, OPERATING MODES

The *CMC 356* has a very large application diversity. The current outputs offer enough output power to test all electromechanical relays.

In particular, the *CMC 356* offers a variety of types of single-phase operation using its two galvanically separated three-phase current outputs with which the output power from the units can be significantly increased.

In cases when the current or the output power - or even the number of independent voltages or currents - is insufficient, it is possible to switch individual amplifier groups of the *CMC 356* in parallel or to connect external amplifiers (up to six independent additional channels) to the "LL out 1-6".

The option "LLO-2" extends the low level outputs by two more independent generator triples "LL out 7-12" (refer to section 6.11, "Option LLO-2 (Low Level Outputs)" on page 90).

The operating modes illustrated in the following sections can be set in the Hardware Configuration of the *OMICRON Test Universe* software.

7.1 Safety Instructions for High Current Output



Observe the following safety instructions when using the operating modes and connection methods described in this chapter.

- For currents greater than 25 A, the test object (load) should be exclusively connected to the 4 mm/0.16 " banana sockets and not to the generator combination socket.
- Since a current of 32 A flowing through a test lead (2 m/6 ft. length, 2.5 mm²) causes a loss of 15 ... 18 W, we recommend to use the connection methods shown in this chapter.
- When connecting current outputs in parallel, it has to be ensured that the test leads are only connected together immediately at the test object and that the test leads have sufficient diameter.
- At maximum amplitude of the 128 A mode, the cable losses can amount to 112 W for AC and 280 W for DC operation.
- At maximum amplitude of the 64 A mode, the cable losses can amount to 28 W for AC and 140 W for DC operation.
- For applications drawing DC current: The test object (load) should be exclusively non-inductive! Note that a load of, for example, 1 Henry can store 50 J (Joule) at 10 A DC for a long period of time. Electrical shocks with more than 350 mJ can be life-hazardous for the user.



7.2 Single-Phase Operation of the CMC 356

7.2.1 1 x 32 A High Burden Mode (L-L-L-L)

1 x 0 ... 32 A ($\pm 45 A_{DC}$), max. 140 V_{peak}, 1 x 1740 VA at 25 A

Both amplifier groups CURRENT OUTPUT A and CURRENT OUTPUT B are connected in series. The currents 1 and 2 of a group are phase-opposite. This results in four times the compliance voltage of a single output.

Observe the safety instructions given in Section 7.1 on page 91 when using this operating mode.

Figure 7-1:
Single-phase operation,
1 x 32 A high burden mode

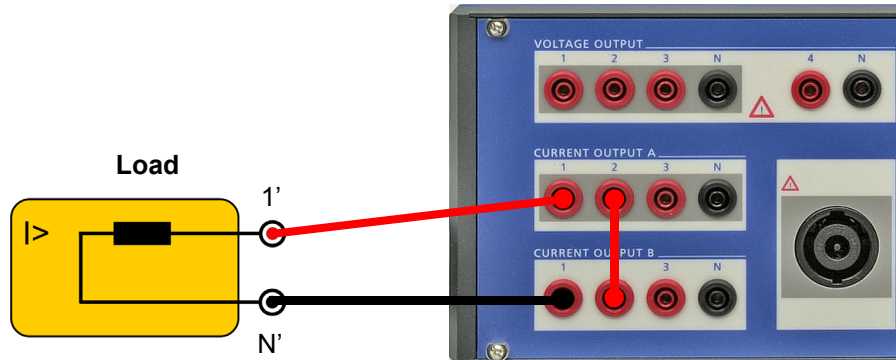
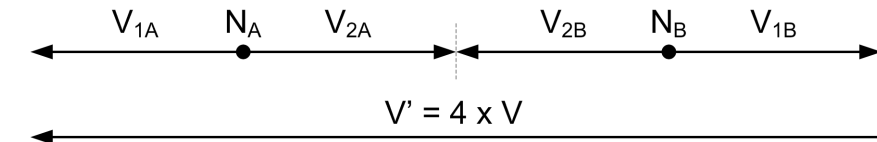

Refer to the output curves shown in the figures 6-1 through 6-5 in section 6.3.2, "Current Outputs" on page 43.

7.2.2 1 x 64 A High Burden and High Current Mode (L-L)

1 x 0 ... 64 A ($\pm 90 A_{DC}$), max. 70 V_{peak}, 1 x 1740 VA at 50 A

The currents 1 and 2 of each group are phase-opposite. In addition, the groups A and B are connected in parallel.

Observe the safety instructions given in Section 7.1 on page 91 when using this operating mode.

Figure 7-2:
Single-phase operation,
1 x 64 A high burden and
high current mode

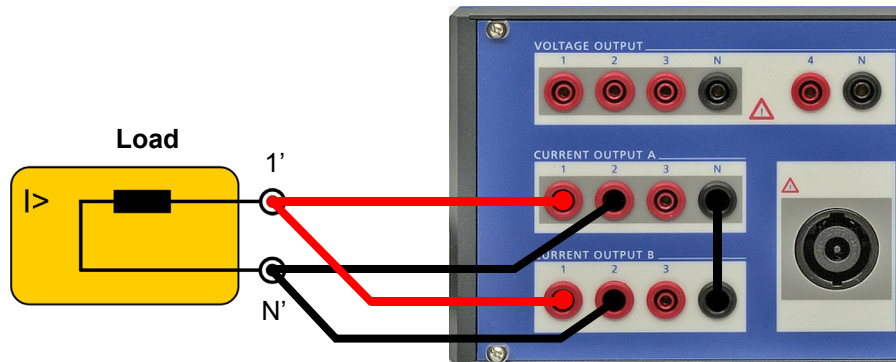
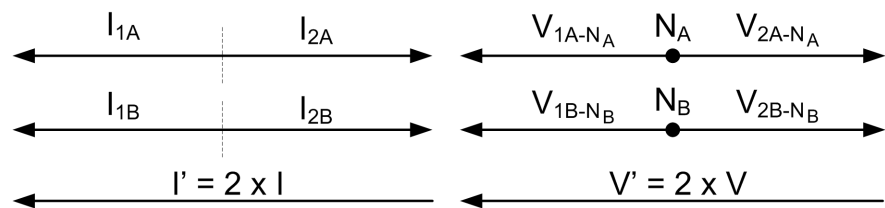

Refer to the output curves shown in the figures 6-1 through 6-5 in section 6.3.2, "Current Outputs" on page 43.

7.2.3 1 x 128 A High Current Mode (LL-LN)

1 x 0 ... 128 A ($\pm 180 A_{DC}$), max. 35 V_{peak}, 1 x 1000 VA at 80 A

Since the current over the N socket is limited to 32 A_{rms} (45 A_{DC}), the third phase is used to support the N socket. The currents 1, 2 of groups A and B are connected in parallel.

Observe the safety instructions given in Section 7.1 on page 91 when using this operating mode.

Figure 7-3:
Single-phase operation,
1 x 128 A high current
mode

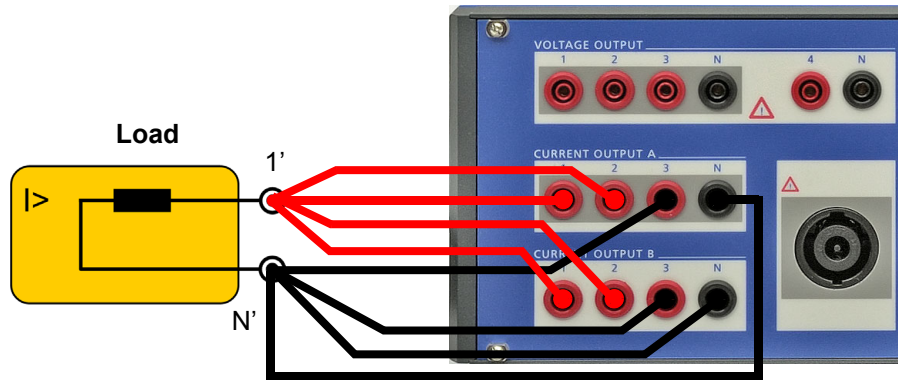
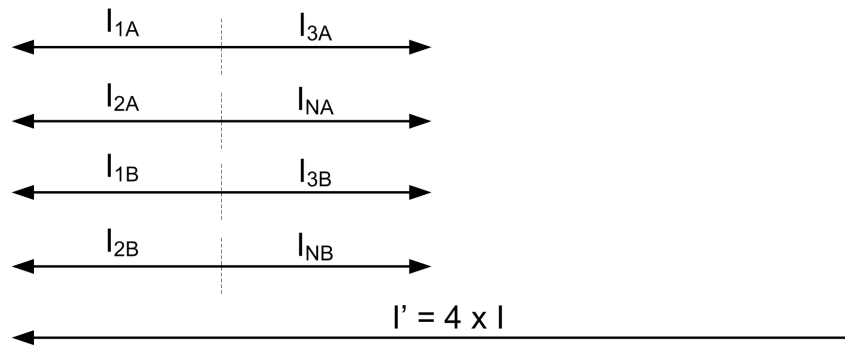

Refer to the output curves shown in the figures 6-1 through 6-5 in section 6.3.2, "Current Outputs" on page 43.

7.2.4 Single-Phase Voltage

1 x 0 ... 300 V, 1 x 200 VA [100 ... 300 V] typical

Figure 7-4:
Single-phase operation of
the voltage system (L-N)

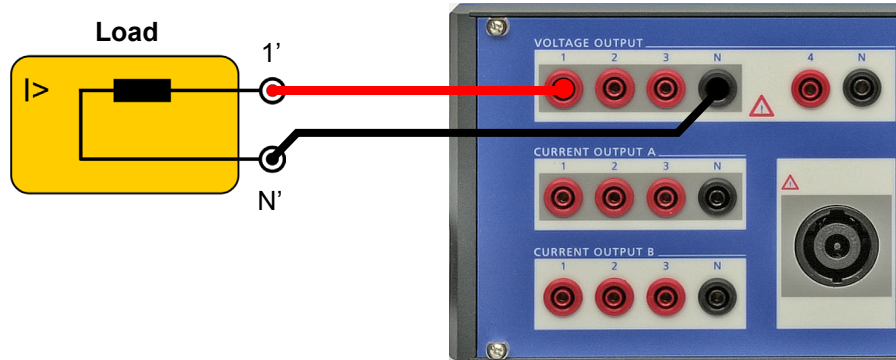

1 x 0 ... 600 V, 1 x 275 VA [200 ... 600 V] typical

Figure 7-5:
Single-phase operation of
the voltage system
(L-L phase opposition)

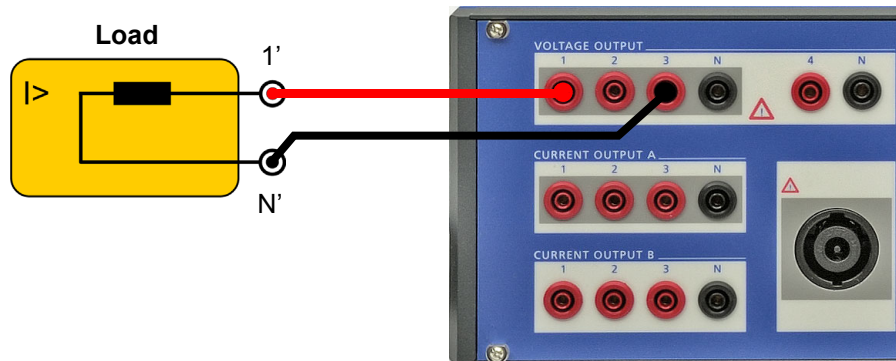

Refer to the output curves shown in the figures 6-8 through 6-9 in section 6.3.3, "Voltage Outputs" on page 48.



Note: Never connect N' or any other phase to GND (PE). This can cause life-hazardous situations to persons and damage to property.

7.3 Two-Phase Operation

For some applications it is beneficial to have two independent currents, each higher than $32 A_{\text{rms}}$, or a higher compliance voltage available.

7.3.1 2 x 64 A High Current Mode (LL-LN)

$2 \times 0 \dots 64 A (\pm 90 A_{\text{DC}})$, max. $35 V_{\text{peak}}$, $2 \times 500 \text{ VA}$ at $40 A$

Since the current over the N socket is limited to $32 A_{\text{rms}}$ ($45 A_{\text{DC}}$), the third phase is used to support the N socket.

Observe the safety instructions given in Section 7.1 on page 91 when using this operating mode.

Figure 7-6:
Two-phase operation,
2 x 64 A high current mode

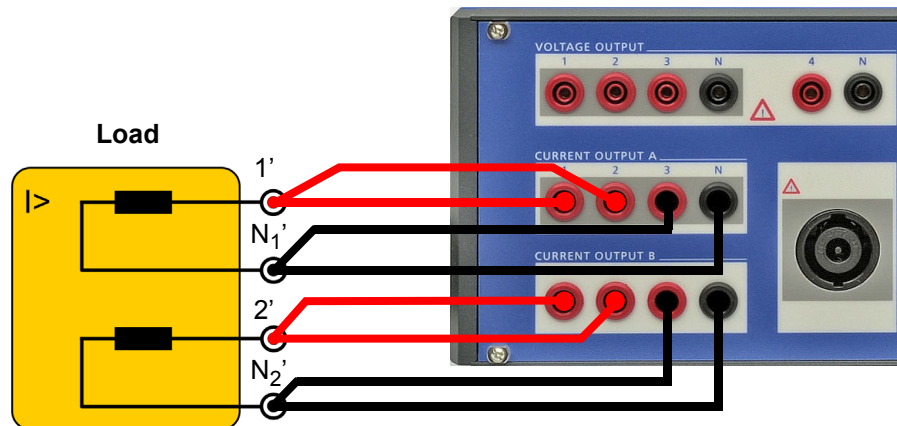

7.3.2 2 x 32 A High Burden Mode (L-L)

$2 \times 0 \dots 32 \text{ A}$ ($\pm 45 \text{ A}_{\text{DC}}$), max. $70 \text{ V}_{\text{peak}}$, $2 \times 870 \text{ VA}$ at 25 A

The currents 1 and 2 of each group are phase-opposite.

Observe the safety instructions given in Section 7.1 on page 91 when using this operating mode.

Figure 7-7:
Two-phase operation
2 x 32 A high burden mode

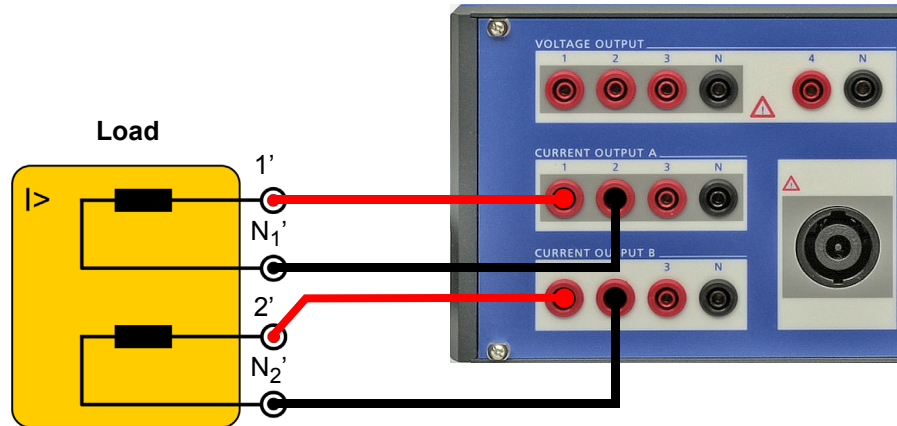

7.4 Three-Phase Current Mode with High Burden

$3 \times 0 \dots 32 \text{ A}$ ($\pm 45 \text{ A}_{\text{DC}}$), max. $70 \text{ V}_{\text{peak}}$, $3 \times 860 \text{ VA}$ at 25 A

For loads with three separate phases it is possible to double the available compliance voltage. However, this configuration does not make sense, if a common N connector is required! **Do not** connect N1, N2 and N3 to each other!

Observe the safety instructions given in Section 7.1 on page 91 when using this operating mode.

Figure 7-8:
Three-phase operation

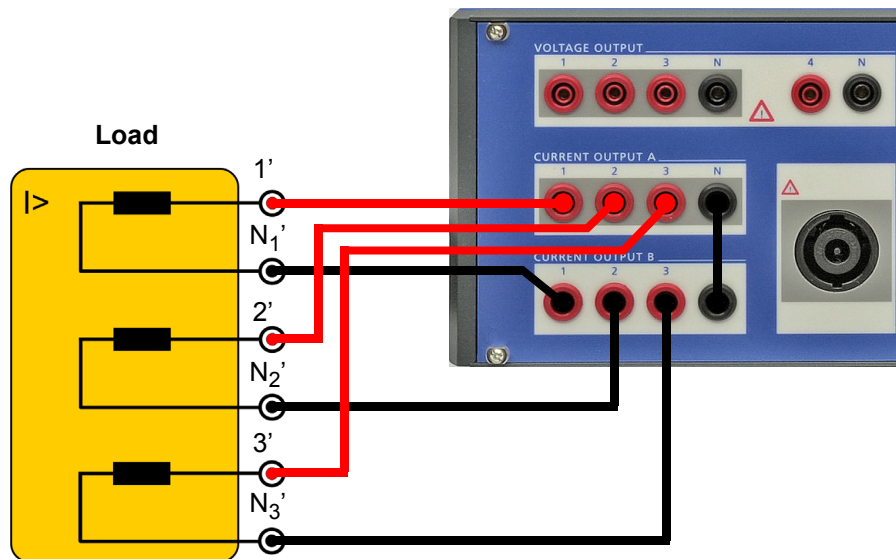

7.5 Operation with External Amplifiers

The connections "LL out 1-6" offer a large variety of extension possibilities. They enable the connection of external amplifiers in order to increase the number of independent voltage or current channels and thus provide the possibility to realize additional applications the *CMC 356* alone cannot cover.

Each LL output socket ("LL out 1-6" and the optional "LL out 7-12") can connect up to four external amplifiers with six independent channels.

The following configurations are possible:

- $9 \times 25 A_{\text{rms}} / 70 \text{ VA}$ for differential relays in three galvanically separated current triples with *CMC 356 + CMA 156*.
- $6 \times 250 \text{ V} / 75 \text{ VA}$ for the synchronization in two galvanically separated voltage triples with *CMC 356 + CMS 156*.

For a complete overview of the supported configurations of the *CMC 356* and *CMA/S* amplifiers see the OMICRON *Test Universe* Help, topic **Hardware Configuration**.

8 TROUBLESHOOTING

8.1 Troubleshooting Guide

In case of operational problems with the *CMC 356* proceed as follows:

1. Consult the reference manual or the *Test Universe* Help.
2. Check whether the malfunction is reproducible and document it.
3. Try to isolate the malfunction by using another computer, test set or connecting cable, if available.
4. Note the exact wording of any error message or unexpected conditions.
5. If you contact the OMICRON technical support, please attach:
 - your company name as well as a phone number and e-mail address
 - the serial number of your test set
 - information about your computer: Manufacturer, type, memory, installed printers, operating system (and language) and the installed version and language of the OMICRON *Test Universe* software.
 - screenshots or the exact wording of possible error messages.
6. If you call the OMICRON hotline, please have your computer and test set available and be prepared to repeat the steps that caused the problem.

To speed up the support, please attach the following diagnostic log files:

- **Communication log file**

This file records any communication between the *CMC 356* and the computer. To send the log file to the OMICRON technical support:

1. Close all other applications.
2. From the *Test Universe* Start Page, select **Calibration & Diagnosis...** and then **Logfile**.
3. Select **Logging on (Detailed)** in the **Edit** menu and minimize the window.
4. Start the test module and reproduce the malfunction.
5. Go back to the log file and select **Send** in the **File** menu to submit the log file via e-mail to the OMICRON technical support.

- **Hardware check log file**

Each time a test module starts, an internal hardware self-check is performed. The results of this test are stored in the hwcheck.log file.

To open the log file, select **Calibration & Diagnosis...** and then **Hardware Check** from the *Test Universe* Start Page.

8.2 Potential Errors, Possible Causes, Remedies

Some potential disruptions that may occur while operating the *CMC 356* are listed below. Try to eliminate them by applying the remedies proposed here.

Table 8-1:
Troubleshooting the
CMC 356

Error	Possible causes	Remedies
Power switch does not light up after turning on the <i>CMC 356</i> test set.	<p>There is no power to the test set.</p> <p>The fuse of the test set is blown</p> <p>Malfunction of internal test set components</p>	<p>Check the power supply and assure that it supplies power to the test set.</p> <p>Unplug the power cord from the power source! Replace the fuse: T 12.5 AH 250 V (5 x 20 mm).</p> <p>Please contact the OMICRON technical support (refer to section "Contact Information / Technical Support" on page 137).</p>
The following message appears in the status line: "WARNING: Broken ground connection! Immediately turn off the test set! Resuming the operation can result in hazard to life and is done at your own risk."	<p>Ground-wire connection to the <i>CMC 356</i> is broken or the test set is powered by an earth-free power supply.</p> <p>Note: Never connect the <i>CMC 356</i> to an isolating transformer.</p>	<p>Check the ground connection.</p> <p>Ground the housing of the test set separately using the PE connection socket (on the back panel of the test set).</p>

8.3 Overheating

If a thermal shutdown occurs because of loading the voltage or current outputs a long time by high burden, the *Test Universe* displays the following messages respectively in the Status History window:

- **“Voltage overtemperature:” followed by a list of the affected outputs**
“CMC switched off.”
“Test stopped with error.”
- **“Current overtemperature:” followed by a list of the affected outputs**
“CMC switched off.”
“Test stopped with error.”

The thermal shutdown can be avoided by reducing the compliance voltage of the current amplifiers, i.e., to optimize the output power limit of the current outputs set the compliance voltage of the internal current amplifiers.

To do so, go to the **Compliance Voltage** group box of the **Output Configuration Details** dialog box in the *Test Universe Hardware Configuration*.

By reducing the power supply voltage, the ON-time can be prolonged considerably for low-ohmic burdens, because this causes the internal amplifier to consume less power. Hence, the internal heat dissipation can be reduced, especially when testing with low burden test objects. This then considerably extends the time until the device switches OFF due to thermal overload.



For more detailed information refer to the *Test Universe* Help. Select the **Hardware Configuration** Help and navigate to the topic **Setting the Current Output Power Limit of CMC Test Sets**.

9 CMC 356-RELATED PRODUCTS AND ACCESSORIES

This chapter describes the optional equipment for the *CMC 356* test set. In the following the amplifiers *CMA 56*, *CMA 156*, *CMS 156*, *CMS 251* and *CMS 252* are jointly named CMA/S. Please visit the OMICRON Web site www.omicron.at for up-to-date information.

9.1 CMA Current Amplifiers & CMS Voltage Amplifiers

The CMA/CMS external amplifiers are controlled by the *CMC 356* test set via the "LL out 1-6" on the rear panel of the test set as shown in figure 9-1 below. The option *LLO-2* extends the low level outputs by two more independent generator triples "LL out 7-12" (refer to section 6.11, "Option LLO-2 (Low Level Outputs)" on page 90).

Figure 9-1:
Connecting a CMA/S
amplifier to the *CMC 356*

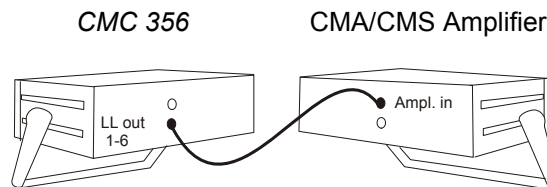

Table 9-1:
Technical data of CMA/S
amplifiers

Amplifier	Output configurations	Output power	Miscellaneous
<i>CMA 156</i>	6-phase current amplifier (Group A, B) 6 × 25 A (L-N) 3 × 50 A (L-N) 2 × 75 A (3L-N) 1 × 150 A (3L-N)	6 × 70 VA at 7.5 A 3 × 140 VA at 15 A 2 × 225 VA at 22.5 A 1 × 420 VA at 45 A	Amplitude accuracy: error < 0.1 %. Weight: 15.4 kg (34 lbs)
<i>CMS 156</i>	3-phase current/voltage amplifier 3 × 250 V (L-N) 1 × 500 V (L-L) 3 × 25 A (L-N) 1 × 75 A (3L-N)	3 × 75 VA 1 × 150 VA 3 × 70 VA at 7.5 A 1 × 210 VA at 22.5 A	Amplitude accuracy: error < 0.1 %. Weight: 14.7 kg (32.4 lbs)

Detailed information about the CMA/S amplifiers can be found in the corresponding user manuals, the product catalog, or on the OMICRON Web site www.omicron.at.

For ordering information about the individual OMICRON amplifiers, please refer to table 9-5, "Order numbers overview" on page 128.

9.2 CMControl-6

Figure 9-2:
CMControl-6 attached to a
CMC 256plus (or in the
same manner to a
CMC 356) test set



Order numbers:

VEHO2806 (CMControl-6); upgrade for an existing CMC 356

VEHO2805 (CMControl-6); add-on for new CMC 356

The *CMControl* is a front panel control device for CMC test sets. Its instant availability and its easy operation concept make it the ideal solution for the quick verification of test objects.

The *CMControl* provides an intuitive touch screen user interface that makes setting up tests particularly easy and convenient. The control wheel allows quick and accurate adjustment of the output quantities. The included test tools and integrated fault models cover almost all common test tasks and support the tester in getting reliable results quickly.

The *CMControl* can either be used attached to the CMC test set as front panel control or detached as a handheld control device. Its magnetic rear allows easy attachment to standard racks while its built-in stand works perfectly on every table.

The *CMControl* is available in two variations: CMControl-6 for CMC 356, CMC 256plus and CMC 256-6, and CMControl-3 for CMC 353.

The rugged Ethernet connector ensures reliable communication with the CMC test set. The *CMControl* is designed to optimally meet the requirements for commissioning and maintenance of protection devices and substations.

For ordering information about the *CMControl*, refer to table 9-5, "Order numbers overview" on page 128.

9.3 Time Synchronization Accessories

9.3.1 CMGPS

You can synchronize two or more CMC test sets by connecting a *CMGPS* synchronization unit to each of the test sets' "ext. Interf." inputs. Since the GPS (Global Positioning System) signal is available worldwide, the physical distance between these test sets is thereby of no relevance ("end to end" testing).

Figure 9-3:
CMGPS synchronization unit

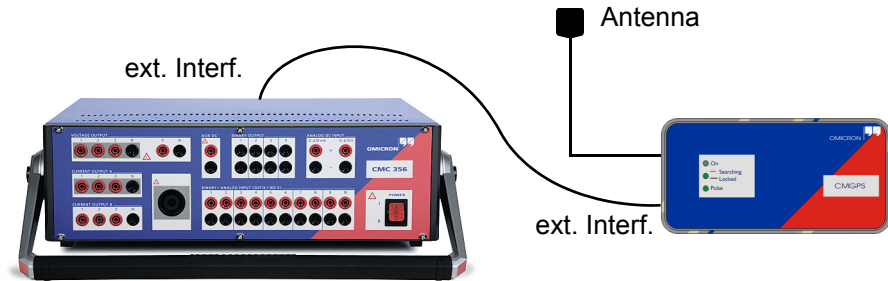

For detailed information about the *CMGPS*, please refer to the *CMGPS* reference manual, the product catalog, or the OMICRON Web site www.omicron.at. For ordering information about the *CMGPS*, refer to table 9-5, "Order numbers overview" on page 128.

Table 9-2:
Basic technical data of the
CMGPS synchronization unit

Pulse outputs	2
Accuracy	Error < $\pm 1 \mu\text{s}$ or $\pm 5 \mu\text{s}$
Synchronization of test sets ¹	Error < $100 \mu\text{s}$ / < $5 \mu\text{s}$ (voltage amplifier) Error < $100 \mu\text{s}$ / < $20 \mu\text{s}$ (current amplifier)
Connection	Voltage supply from the <i>CMC 356</i> test set. Configured by the <i>Test Universe</i> software.
Weight	440 g (1 lbs)
Dimensions W x H x D	140 x 70 x 40 mm (5.5 x 2.8 x 1.6 ")

¹ Error corresponds to amplifier output signals (voltage/current) of *CMGPS*-synchronized test sets at configured GPS trigger event
 $5 \mu\text{s}$ / $20 \mu\text{s}$: enhanced mode only in supported *Test Universe* test modules (refer to *Test Universe* Help, topic "Time Trigger Configuration").

Figure 9-4:
CMGPS connected to antenna via 2 × 20 m extension cables

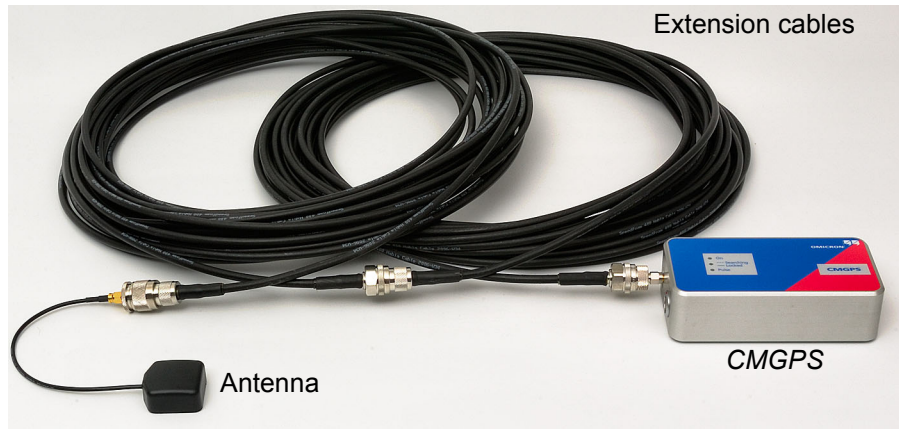

For cases that may require an extension of the antenna cable, an optional set of 2 × 20 m cables is available from OMICRON. For ordering information, refer to table 9-5, "Order numbers overview" on page 128.

Figure 9-5:
Adapter to connect the extension cables to CMGPS and antenna

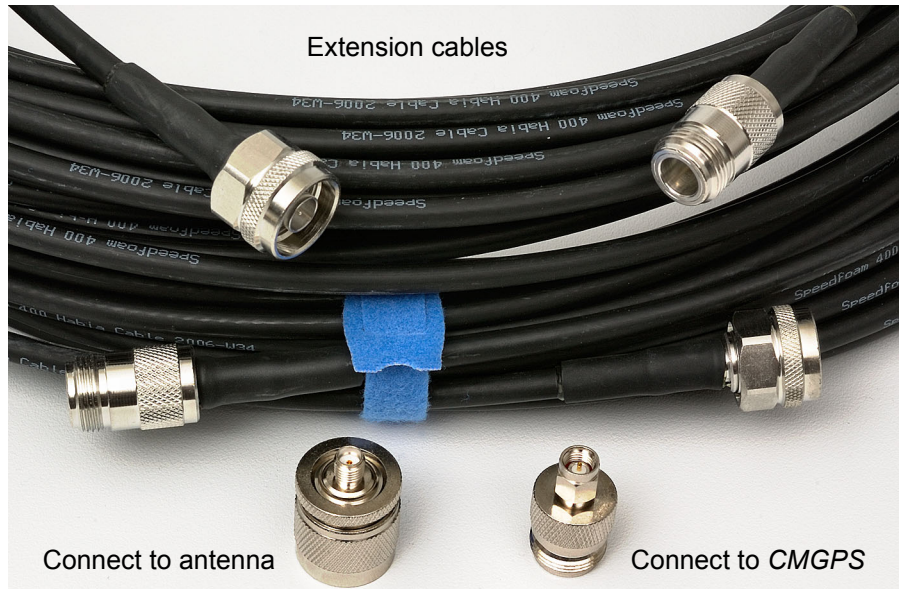

9.3.2 CMIRIG-B

Via the *CMIRIG-B* interface box you can connect devices to the *CMC 356* test set that either transmit or receive the IRIG-B time reference signal (DC level shift protocol B00x). That way, two or more CMC test sets are synchronized. Furthermore, an optional *CMGPS* synchronization unit can be integrated into the test setup to serve as source of the synchronization moment or 1PPS signal, respectively. *CMC 356* decodes (when receiving) or encodes (when transmitting) the IRIG-B protocol. The IRIG-B protocol extensions required by standard IEEE C37.118 are supported as well.

The most significant functional enhancement of those *Test Universe* test modules supporting the IRIG-B time reference is the starting and synchronizing of *CMC 356* states (signal output) with high accuracy synchronous to the IRIG-B¹ time reference or PPS/PPX² signal, respectively; for example for PMU synchrophasor tests.

Figure 9-6:
Typical test setup with
CMIRIG-B
(not true to scale)

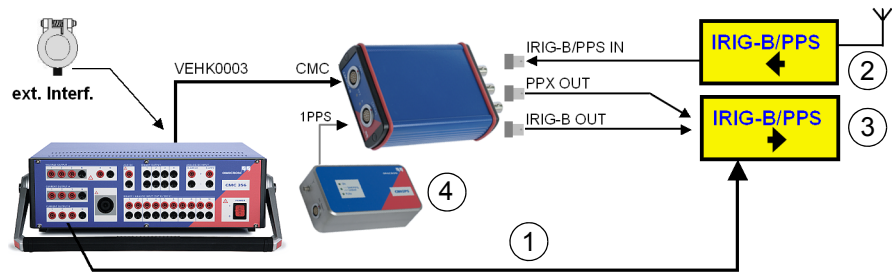

- ① Test signals (e.g., 3 x current, 3 x voltage).
- ② IRIG-B/PPS source, e.g. GPS receiver with IRIG-B output.
- ③ IRIG-B/PPS receiver, e.g. protection relay, PMU.
- ④ Optional *CMGPS* synchronization unit (depends on the application).

Requirements:

- *CMC 356* standard test set with Ethernet ports.
- IRIG-B source or receiver with 5 V/TTL level; demodulated; DC level shift protocol (B00x).

¹ IRIG stands for Inter Range Instrumentation Group and represents a serial time code format.

² PPS: pulses per second
PPX: programmable PPS signal (pulse rate, e.g., 1 pulse per minute or one pulse per 10 seconds)

CMIRIG-B timing specifications

Figure 9-7:
CMIRIG-B timing in detail

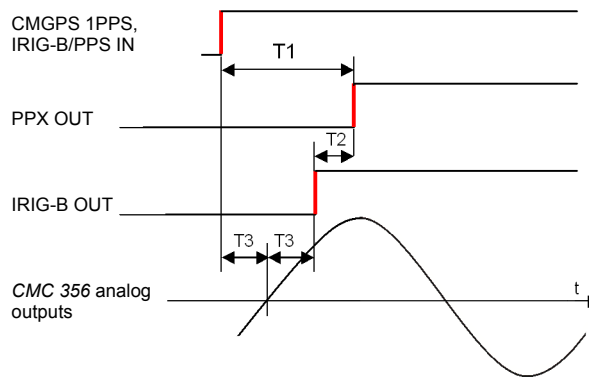

Table 9-3:
Timing specifications

Timing specifications	
T1 (delay time PPS source to PPX OUT)	< 1 μ s typ., 1.5 μ s max.
T2 (time skew PPX OUT to IRIG-B OUT)	< \pm 0.1 μ s typ., \pm 0.5 μ s max.
T3 (time error of time reference source to analog outputs) ¹	
- Current outputs	\pm 5 μ s typ., \pm 20 μ s guar.
- Voltage outputs	\pm 1 μ s typ., \pm 5 μ s guar.

¹ Valid for CMC 356 output frequencies < 100Hz and re-synchronized analog output signals.

For ordering information about the *CMIRIG-B*, refer to table 9-5, "Order numbers overview" on page 128.



For detailed information about the OMICRON *CMIRIG-B* interface box please refer to the *CMIRIG-B* Reference Manual.



Detailed information about the IRIG-B standard can be found, for example, in the IRIG SERIAL TIME CODE FORMATS publication at the url <https://wsgrc2vger.wsmr.army.mil/rcc/manuals/200-04/index.html>.



Detailed information about how to configure the *Test Universe* software component **Time Trigger Configuration**  for the use of *CMIRIG-B* with or without *CMGPS* can be found in the *CMIRIG-B* Reference Manual and in the *Test Universe* Help, topics **Time Trigger Configuration** and **Hardware Configuration (IRIG-B & GPS tab)**.

9.4 100TX to 100FX-SC Converter

Figure 9-8:
100TX to 100FX-SC
Converter



Order number: VEHZ0021

This converter connects the *CMC 356* to a network via fiber optics.

The *100TX to 100FX-SC Converter* transfers data from a 10/100Base-TX copper to a fiber interface. It is designed to receive both data and power from PoE networks, and to pass on the data to a fiber optics connection.

9.5 Current Clamp C-PROBE1

Using the current clamp *C-PROBE1* and the option ELT-1, direct and alternating currents can be measured via the analog measurement inputs of the BINARY / ANALOG INPUT section (refer to section 6.10, "Option ELT-1" on page 67).

C-PROBE1 is an active, DC-capable current probe and has two switchable measurement ranges.

Figure 9-9:
Current clamp *C-PROBE 1*

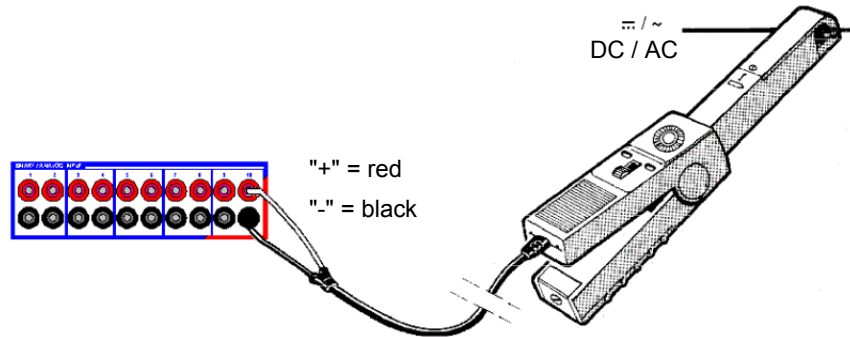

For detailed information about the *C-PROBE1* current clamp and the option ELT-1, please refer to the respective reference manuals, the product catalog, or visit the OMICRON Web site www.omicron.at.

Table 9-4:
Basic technical data of
C-PROBE 1

Max. voltage of the leads	600 V _{rms} to GND	
Switch position	100 mV/A	10 mV/A
Measurement ranges	0...10 A AC/DC	0...80 A AC/DC
Frequency bandwidth	0 (DC)...10 kHz	

For ordering information about the *C-PROBE-1*, please refer to table 9-5, "Order numbers overview" on page 128.

9.6 Accessories for Meter Testing

9.6.1 Scanning Head OSH256

The passive optical scanning head *OSH256* detects the status of an LED, that is either an optical pulse output from an energy meter or the binary status of a protective relay or other similar optical source.

Figure 9-10:
The optical scanning head *OSH256* attached to an energy meter by rubber adhesive

Reusable adhesive rubber compound (additionally screens the sensor from ambient light)

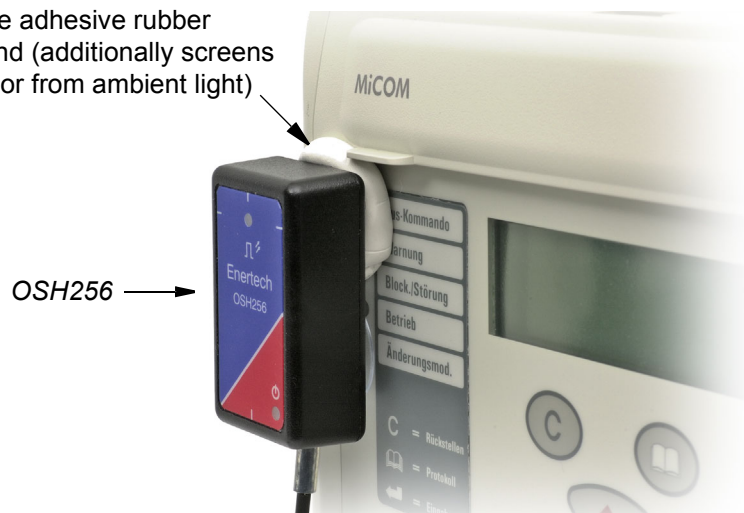

Order number: **VEHZ2006**

The *OSH256* has a unique fixing method as the lightweight unit can be attached to smooth surfaces by means of its suction cup (figure below) or by a re-usable adhesive rubber compound in case of a non-planar surface (figure above).

Figure 9-11:
Suction cup of the optical scanning head *OSH256*



The *OSH256* connects to the EXIF socket of a *CMC 356* by means of the adapter cable *VEHK0010* (refer to section 9.6.5, "Adapter Cable for Scanning Heads" on page 117) or a *CMLIB B* (refer to section 9.6.6, "CMLIB B" on page 118).

For relay testing applications the *IFB256* serves to connect to a binary input of a *CMC* test set (refer to section 9.6.2 below).

9.6.2 Interface Box IFB256

Typically, the combination of a scanning head *OSH256* with an interface box *IFB256* is used for relay testing when binary information (a trigger signal) originates from a relay's LED. The *IFB256* is directly connected to the EXIF socket of a *CMC 356*, which provides the auxiliary DC supply through the *IFB256* to the scanning head. The binary signal is connected to the inputs of the *CMC* via banana plug leads.

Figure 9-12:
Interface box *IFB256*



Order number: VEHZ1152

9.6.3 Scanning Head TK 326

The photoelectric scanning head *TK 326* is suitable for scanning of all known rotor marks of Ferraris meters and for scanning of LEDs up to the infrared wavelength range. It includes a spiral cable for the connection to the adapter cable or to a *CMLIB B*.

Figure 9-13:
The photoelectric scanning
head *TK 326*



Order number: VEHZ2008

The *TK 326* connects to the EXIF socket of a *CMC 356* by means of the adapter cable *VEHK0010* (refer to section 9.6.5, "Adapter Cable for Scanning Heads" on page 117) or a *CMLIB B* (refer to section 9.6.6, "CMLIB B" on page 118).

9.6.4 Scanning Head TVS 6.15/1

The magnetic scanning head **TVS 6.15/1** (dia. 32 mm/1.3") is available for electronic meters with optical pulse outputs and matching mechanical interface.

Figure 9-14:
The magnetic scanning
head *TVS 6.15/1*



Order number: VEHZ2004

The *TVS 6.15/1* connects to the EXIF socket of a *CMC 356* by means of the adapter cable *VEHK0010* (section 9.6.5 on page 117) or a *CMLIB B* (section 9.6.6 on page 118).

9.6.5 Adapter Cable for Scanning Heads

The adapter cable VEHK0010 connects the scanning heads *OSH256*, *TK 326* and *TVS 6.15/1* directly to a *CMC 356* test set. The scanning heads connection cable is simply extended by the adapter cable plugging the 5-pole LEMO connectors into each other. The 16-pole LEMO connector is plugged into the LEMO socket "ext. Interf." at the rear of a CMC test set. From there the scanning heads are supplied with 14 VDC and meter pulses are fed to the counter input of the CMC.

Figure 9-15:
Connecting an optical scanning head to the CMC 356 "ext. Interf." connector

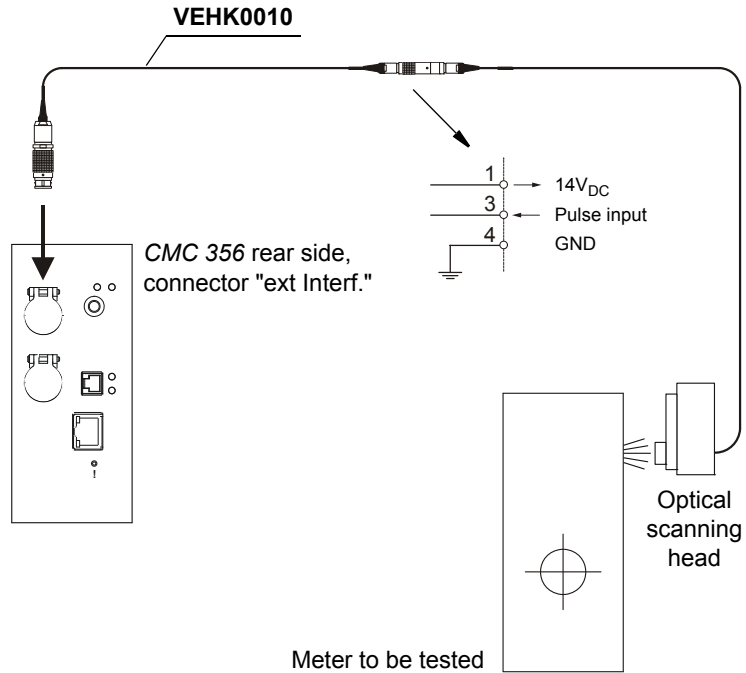

Figure 9-16:
Adapter cable for scanning heads



For ordering information about scanning heads, please refer to table 9-5, "Order numbers overview" on page 128.

9.6.6 CMLIB B

There are some meter testing applications where the simple adapter cable (section 9.6.5) does not prove sufficient for the test setup:

- if a reference meter is used and therefore two pulse inputs are required
- if the binary transistor outputs of a *CMC 356* test set need to be accessed.

For these applications, the *CMLIB B* is used as interface.

Figure 9-17:
Connecting a *CMLIB B*

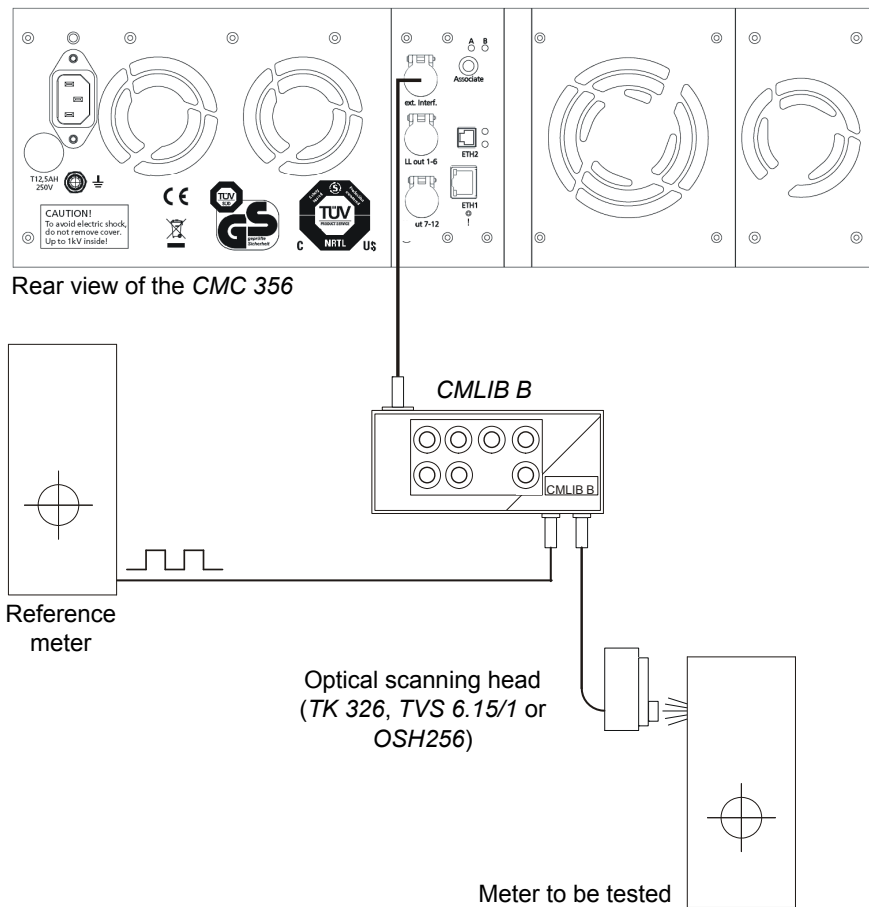

For detailed information about the *CMLIB B*, please refer to the *CMLIB B* reference manual, the product catalog, or visit the OMICRON Web site www.omicron.at. For ordering information about the *CMLIB B*, please refer to table 9-5, "Order numbers overview" on page 128.

9.6.7 CMLIB A

CMLIB A is connected between a CMC test set and an amplifier to tap the analog low level signal outputs. Furthermore, *CMLIB A* can be connected to the analog control inputs of the optional amplifiers *CMA 156* and *CMS 156*.

Applications for *CMLIB A*:

- Connection of amplifiers that do not have an OMICRON connection socket to the CMC analog low level signal outputs.
- Connection of OMICRON amplifiers to controlling sources that do not have an OMICRON connection socket.
- Convenient tapping of the signals between the CMC test set and OMICRON amplifiers.

Figure 9-18:
CMLIB A

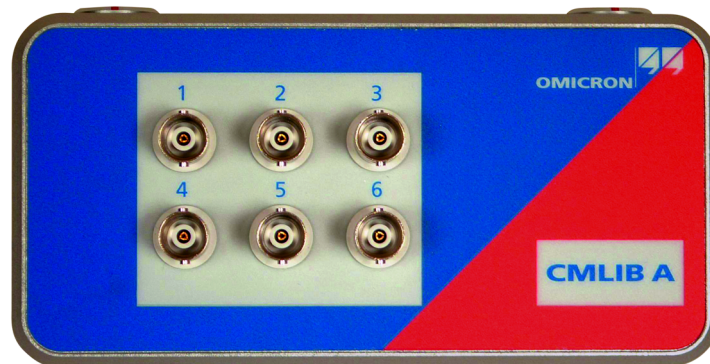

Order number: VEHZ1101

The *CMLIB A* set (**VEHZ1105**) includes the *CMLIB A* interface box (VEHZ1101) as shown above in figure 9-18, and the 16-pole LEMO cable (**VEHK0003**) to connect the interface box to either a CMC test set or an OMICRON amplifier.

CMLIB A accessory cables

Figure 9-19:
CMLIB A accessory cables



BNC to BNC
Order number: **VEHK0008**



BNC to 4 mm banana cables
Order number: **VEHK0005**

The *CMLIB A* accessory cables are to be ordered separately. Each order number represents one piece of cable.

9.6.8 CPOL Polarity Tester



The portable and easy-to-use *CPOL* Polarity Tester is designated to check a series of test points for correct polarity as a substitute for the battery checking method.

The *CMC 356* injects a special continuous voltage or current test signal at one point. Then *CPOL* checks the polarity at all terminals and provides a clear indication as to whether the polarity is OK (green LED) or not (red LED). This procedure is much faster than the conventional method and can easily be performed by a single person.

CPOL is used in conjunction with the *Polarity Checker* test tool that is part of the *Test Universe* software.

Order number: VEHZ0645

9.6.9 Connection Cable for REF 54x Relays (ABB) with Low Level Signal Inputs

This connection cable with twin-BNC clamp plugs type AMPHENOL 31-224 is tailored to connect ABB relays of the REF 54x series (with AMPHENOL twin-BNC bulkhead receptacles type 31-223) to the low level outputs of the CMC 356 (16-pole LEMO connector).

Figure 9-20:
REF 54x cable connector

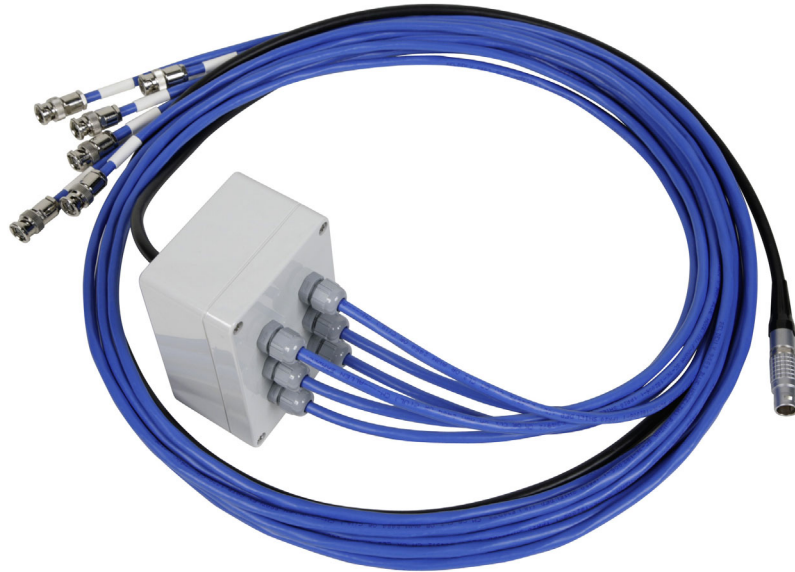

Order number: VEHK0120

Cable length: approx. 2.5 m (8.2 feet).

The six cable tails with the AMP connectors are labeled.

The CMC test set in such applications simulates unconventional transformers and/or Rogowski coils.

9.6.10 C-Shunt

C-Shunt 1 and *C-Shunt 10* are precision shunts for current measurements. They can be directly inserted into the binary/analog inputs of a *CMC 356* with *ELT-1* option. The *ELT-1* option enables the *CMC 356* to measure analog signals; see 6.10 "Option *ELT-1*" on page 67.

Figure 9-21:
C-Shunt 1

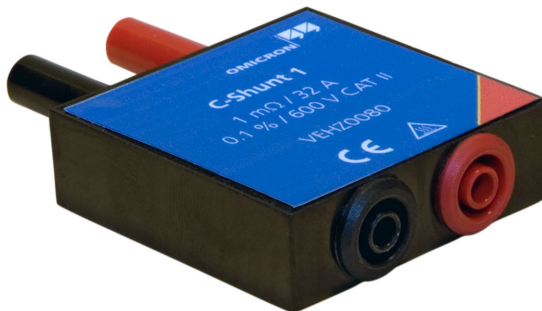

Order numbers:

C-Shunt 1: VEHZ0080

C-Shunt 10: VEHZ0081

C-Shunt 1	
Electrical resistance	0.001 Ω
Resistance Tolerance	0.1 %
Temperature coefficient	≥ 30 ppm/K in the range 0 ... +70 °C (32 ... +158 °F); according to IEC 60115-1 4.8
Maximum current	32 A continuous
Insulation class	600 V CAT II

C-Shunt 10 is a 10 mΩ precision shunt for current measurements. It can be directly inserted into the test set's binary/analog inputs.

C-Shunt 10	
Electrical resistance	0.01 Ω
Resistance Tolerance	0.1 %
Temperature coefficient	≥ 18 ppm/K in the range 0 ... +70 °C (32 ... +158 °F); according to IEC 60115-1 4.8
Maximum current	12.5 A continuous
Insulation class	600 V CAT II

9.7 Wiring Accessories

9.7.1 Standard Delivery Scope

The following three articles belong to the standard delivery scope of a *CMC 356* test set. They can, however, also be ordered separately.

1. Flexible test lead

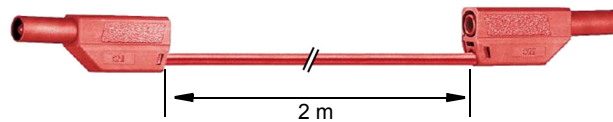

Order number: VEHK0112

2 m (6 ft.) test lead to connect the *CMC 356* output to other safety sockets of, for example, amplifiers, test objects or to banana adapters in control cabinets.

Specification: 1000 V/32 A

Amount supplied: 6 x red, 6 x black

2. Flexible jumper



Order number: VEHZ0009

Flexible jumper to connect current outputs in parallel (up to 32 A) or to short-out the neutrals of binary inputs.

Specification: 1000 V/32 A

Amount supplied: 4 x black

3. Flexible terminal adapter



Order number: VEHS0009

Flexible terminal adapter to connect to screw-clamp terminals.

Specification: 1000 V/32 A

Amount supplied: 12 pieces

9.7.2 Optional CMC Wiring Accessory Package

Figure 9-22:
The CMC Wiring
Accessory Package



Order number: VEHZ0060

The CMC Wiring Accessory Package contains the following articles:

1. Flexible test lead adapter

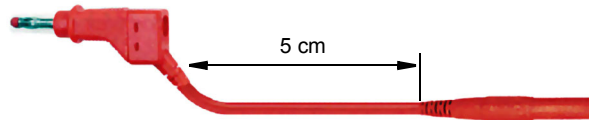

5 cm (2") test lead adapter with retractable sleeve to connect the *CMC 356* output to non-safety sockets in combination with a regular flexible 2 m (6 ft.) test lead as shown at section 9.7.1.

Specification: 600 V/32 A

Amount: 6 x red, 6 x black

2. Flexible jumper



Flexible jumper to connect current outputs in parallel (up to 32 A) or to short-out the neutrals of binary inputs. Identical to article of standard delivery scope listed under 9.7.1.

Specification: 1000 V/32 A

Amount: 4 x black

3. Crocodile clamp



Crocodile clamps for secondary side to connect to pins or screw bolts.

Specification: 1000 V/32 A

Amount: 4 x red, 4 x black

4. Flexible terminal adapter



Flexible terminal adapter to connect to screw-clamp terminals. Identical to article of standard delivery scope listed under 9.7.1.

Specification: 1000 V/32 A

Amount: 12 pieces

5. M4 (0.15") Cable Lug Adapters



Cable lug adapters for M4 (0.15") screws to connect regular test leads to screw-clamp terminals of SEL/ABB/GE relays (and others).

Specification: 1000 V/20 A

Amount: 20 pieces

6. M5 (0.2") Cable Lug Adapters



Cable lug adapters for M5 (0.2") screws to connect regular test leads to screw-clamp terminals of SEL/ABB/GE relays (and others).

Specification: 1000 V/20 A

Amount: 10 pieces

7. Cable Tie (Velcro fastener)



Cable Tie (Velcro fastener), length 150 mm (6"), black.

Amount: 10 pieces

9.8 Ordering Information

This section lists the order numbers for optional equipment of the *CMC 356* test set.

Figure 9-23:
Connection cables I

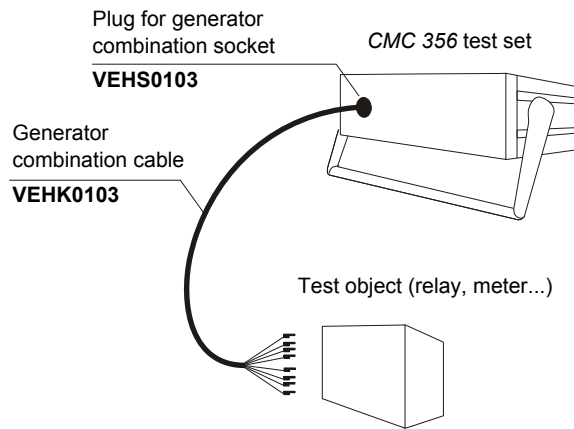

Figure 9-24:
Connection cables II

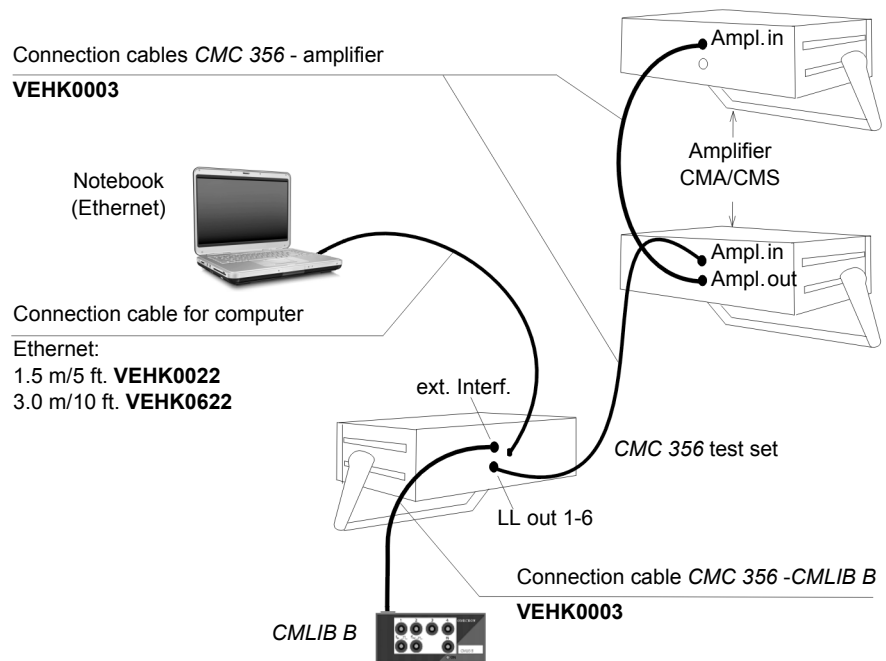

Table 9-5:
Order numbers overview

Article	Order no.
CMC 356 options (factory upgrade)	
ELT-1 <i>Enerlyzer</i> and Transducer Inputs (→ section 6.10)	VEHO2802
LLO-2 Low level outputs LL out 7 - 12 (→ section 6.11)	VEHO2804
FL-6 Constraints the maximum output frequency to 599 Hz (→ section 2.1)	VEHO0599
Amplifiers (→ section 9.1)	
<i>CMA 156</i> Current amplifier (6×25 A)	VEHV1010
<i>CMS 156</i> Voltage/current amplifier (3×250 V, 3×25 A)	VEHV1030
CMControl-6 (→ section 9.2)	
CMControl-6; upgrade for an existing <i>CMC 356</i> (includes soft bag VEHP0014)	VEHO2806
CMControl-6; add-on for a new <i>CMC 356</i>	VEHO2805
CMIRIG-B Interface box (→ section 9.3.2)	
<i>CMIRIG-B</i> Interface box incl. all accessories	VEHZ1150
<i>CMIRIG-B</i> Interface box	VEHZ1151
Connection cable <i>CMIRIG-B</i> ↔ <i>CMC 356</i>	VEHK0003
CMGPS Synchronization unit (→ section 9.3.1)	
<i>CMGPS</i> Synchronization unit, consisting of: - <i>CMGPS</i> synchronization unit - antenna - 15 m antenna cable - power supply unit - 16-pole LEMO cable CMC-CMGPS - carrying bag	VEHZ3000
2 × 20 m antenna extension cable and SMA adapter	VEHZ3003
100TX to 100FX-SC Converter (→ section 9.4)	
Converter for data transfer from a 10/100Base-TX copper to a fiber interface.	VEHZ0021
Current clamp (→ section 9.5)	
<i>C-PROBE1</i> Current clamp (10/80 A range, DC ... 10 kHz)	VEHZ4000

Article	Order no.
Meter testing accessories	
<i>OSH256</i> Passive scanning head, suction and adhesive fixation (→ section 9.6.1)	VEHZ2006
<i>IFB256</i> Interface Box for scanning head <i>OSH256</i> ; used for relay testing when binary information originates from a relay's LED. (→ section 9.6.2)	VEHZ1152
<i>TK 326</i> Active and passive scanning head, mechanical fixation (→ section 9.6.3)	VEHZ2008
<i>TVS 6.15/1</i> Passive scanning head, magnetic fixation (→ section 9.6.4)	VEHZ2004
Adapter cable for scanning heads (→ section 9.6.5)	VEHK0010
<i>CMLIB B</i> Interface box for - testing with reference meters - accessing the transistor outputs. (→ section 9.6.6)	VEHZ1102
<i>CMLIB A</i> Interface box to - connect non-OMICRON amplifiers - tap the analog low level signal outputs of an amplifier.	VEHZ1101
<i>CMLIB A</i> cable BNC to BNC	VEHK0008
<i>CMLIB A</i> cable BNC to 4 mm banana (→ section 9.6.7)	VEHK0005
<i>CPOL</i> Polarity Tester (→ section 9.6.8)	VEHZ0645
Connection cable for REF 54x Relays (ABB) with low level signal inputs (→ section 9.6.9)	VEHK0120
<i>C-Shunt</i> Precision shunts for current measurements - <i>C-Shunt 1</i> : 0.001 Ω - <i>C-Shunt 10</i> : 0.01 Ω (→ section 9.6.10)	VEHZ0080 VEHZ0081
Connector	
Plug for generator combination socket (→ section 5.1.1)	VEHS0103

Article	Order no.
Cables	
Ethernet cable 1.5 m /5 ft.	VEHK0022
Ethernet cable 3.0 m/10 ft.	VEHK0622
Connection cable CMC 356-to-amplifier, CMLIB A/B or CMGPS	VEHK0003
Generator combination cable	VEHK0103
Wiring accessories (→ section 9.7)	
Flexible test lead 1000 V/32 A, 6 x red, 6 x black	VEHK0112
CMC Wiring Accessory Package containing the following items: <ol style="list-style-type: none"> 1. Flexible test lead with retractable sleeve, 600 V/32 A, 6 x red, 6 x black 2. Flexible jumper, 600 V/32 A, 4 x black 3. Crocodile clamps, 1000 V/32 A, 4 x red, 4 x black 4. Flexible terminal adapter, 1000 V/32 A, black, 12 pieces 5. M4 (0.15") Cable Lug Adapters, 1000 V/20 A, 20 pieces 6. M5 (0.2") Cable Lug Adapters, 1000 V/20 A, 10 pieces 7. Cable Tie (Velcro fastener), length 150 mm (6"), 10 pieces 8. OMICRON Accessory Bag, 1 piece 	VEHZ0060

Article	Order no.
<p>Heavy-duty transport case with wheels and extendable handle for the <i>CMC 356</i> test set with or without <i>CMControl-6</i>, for <i>CMB IO-7</i>, and for <i>CMA</i> or <i>CMS</i> amplifiers.</p> 	<p>VEHP0021</p>
<p>Soft bag for <i>CMC 356</i> test set</p> <p>Soft bag for <i>CMC 356</i> test set with attached <i>CMControl-6</i></p> 	<p>VEHP0012</p> <p>VEHP0014</p>

APPENDIX

The OMICRON Bootloader software

The OMICRON Bootloader software includes software parts developed by:

- Intel Corporation (IXP400 SW Release version 2.3)
- Intrinsic Software (Intrinsic Bootloader)
- Swedish Institute of Computer Science, Adam Dunkels (lwIP TCP/IP stack)
- Mark Adler (puff - decompress the deflate data format)
- Jean-loup Gailly and Mark Adler ("zlib" general purpose compression library)

The following copyright notices reproduce entirely the copyright notices provided by the source code owners.

IXP400 SW Release version 2.3

Copyright (c) 2001-2005, Intel Corporation. All rights reserved.

Redistribution and use in source and binary forms, with or without modification, are permitted provided that the following conditions are met:

1. Redistributions of source code must retain the above copyright notice, this list of conditions and the following disclaimer.
2. Redistributions in binary form must reproduce the above copyright notice, this list of conditions and the following disclaimer in the documentation and/or other materials provided with the distribution.
3. Neither the name of the Intel Corporation nor the names of its contributors may be used to endorse or promote products derived from this software without specific prior written permission.

This software is provided by the copyright holders and contributors "as is" and any express or implied warranties, including, but not limited to, the implied warranties of merchantability and fitness for a particular purpose are disclaimed. In no event shall the copyright owner or contributors be liable for any direct, indirect, incidental, special, exemplary, or consequential damages (including, but not limited to, procurement of substitute goods or services; loss of use, data, or profits; or business interruption) however caused and on any theory of liability, whether in contract, strict liability, or tort (including negligence or otherwise) arising in any way out of the use of this software, even if advised of the possibility of such damage.

Intrinsic Bootloader

Copyright (c) 2001-2002, Intrinsic Software. All rights reserved.

Redistribution and use in source and binary forms, with or without modification, are permitted provided that the following conditions are met:

1. Redistributions of source code must retain the above copyright notice, this list of conditions and the following disclaimer.
2. Redistributions in binary form must reproduce the above copyright notice, this list of conditions and the following disclaimer in the documentation and/or other materials provided with the distribution.

3. All advertising materials mentioning features or use of this software must display the following acknowledgement: This product includes software developed by Intrinsyc Software.
4. The name of Intrinsyc may not be used to endorse or promote products derived from this software without specific prior written permission.

This software is provided by Intrinsyc software and contributors "as is" and any express or implied warranties, including, but not limited to, the implied warranties of merchantability and fitness for a particular purpose are disclaimed. In no event shall Intrinsyc software be liable for any direct, indirect, incidental, special, exemplary, or consequential damages (including, but not limited to, procurement of substitute goods or services; loss of use, data, or profits; or business interruption) however caused and on any theory of liability, whether in contract, strict liability, or tort (including negligence or otherwise) arising in any way out of the use of this software, even if advised of the possibility of such damage.

lwIP TCP/IP stack

Author: Adam Dunkels <adam@sics.se>

Copyright (c) 2001, 2002 Swedish Institute of Computer Science. All rights reserved.

Redistribution and use in source and binary forms, with or without modification, are permitted provided that the following conditions are met:

1. Redistributions of source code must retain the above copyright notice, this list of conditions and the following disclaimer.
2. Redistributions in binary form must reproduce the above copyright notice, this list of conditions and the following disclaimer in the documentation and/or other materials provided with the distribution.
3. The name of the author may not be used to endorse or promote products derived from this software without specific prior written permission.

This software is provided by the author "as is" and any express or implied warranties, including, but not limited to, the implied warranties of merchantability and fitness for a particular purpose are disclaimed. In no event shall the author be liable for any direct, indirect, incidental, special, exemplary, or consequential damages (including, but not limited to, procurement of substitute goods or services; loss of use, data, or profits; or business interruption) however caused and on any theory of liability, whether in contract, strict liability, or tort (including negligence or otherwise) arising in any way out of the use of this software, even if advised of the possibility of such damage.

puff (Mark Adler)

This software is provided 'as-is', without any express or implied warranty. In no event will the author be held liable for any damages arising from the use of this software.

Permission is granted to anyone to use this software for any purpose, including commercial applications, and to alter it and redistribute it freely, subject to the following restrictions:

1. The origin of this software must not be misrepresented; you must not claim that you wrote the original software. If you use this software in a product, an acknowledgment in the product documentation would be appreciated but is not required.
2. Altered source versions must be plainly marked as such, and must not be misrepresented as being the original software.
3. This notice may not be removed or altered from any source distribution.

Mark Adler <madler@alumni.caltech.edu>

zlib (Jean-loup Gailly and Mark Adler)

Copyright (C) 1995-2002 Jean-loup Gailly and Mark Adler.

This software is provided 'as-is', without any express or implied warranty. In no event will the authors be held liable for any damages arising from the use of this software.

Permission is granted to anyone to use this software for any purpose, including commercial applications, and to alter it and redistribute it freely, subject to the following restrictions:

1. The origin of this software must not be misrepresented; you must not claim that you wrote the original software. If you use this software in a product, an acknowledgment in the product documentation would be appreciated but is not required.
2. Altered source versions must be plainly marked as such, and must not be misrepresented as being the original software.
3. This notice may not be removed or altered from any source distribution.

Mark Adler <madler@alumni.caltech.edu>

Jean-loup Gailly <jloup@gzip.org>

The data format used by the zlib library is described by RFCs (Request for Comments) 1950 to 1952 in the files ftp://ds.internic.net/rfc/rfc1950.txt (zlib format), rfc1951.txt (deflate format) and rfc1952.txt (gzip format).

Contact Information / Technical Support

North and South America

OMICRON electronics Corp. USA

12 Greenway Plaza, Suite 1510

Houston, TX 77046, USA

Phone: +1 713 830-4660 or 1 800 *OMICRON*

E-Mail: techsupport@omicronusa.com

Web: <http://www.omicronusa.com>

Asia, Pacific

OMICRON electronics Asia Ltd.

Suite 2006, 20/F, Tower 2

The Gateway, Harbour City

Kowloon, Hong Kong S.A.R.

Phone: +852 2634 0377

E-Mail: support@asia.omicron.at

Web: <http://www.omicron.at>

Europe, Africa, Middle East

OMICRON electronics GmbH

Oberes Ried 1

6833 Klaus, Austria

Phone: +43 5523 507-333

E-Mail: support@omicron.at

Web: <http://www.omicron.at>

For addresses of OMICRON offices with customer service centers, regional sales offices or offices for training, consulting and commissioning, please see the **Contact** section of our Web site <http://www.omicron.at>.

INDEX

Numerics

599 Hz restriction13, 41, 48, 53, 128

A

accessories

adapter cable for scanning heads117
 CMA/S current/voltage amplifiers105
 CMGPS107
 CMIRIG-B109
 CMLIB B118
 connecting cables123
 C-PROBE1112
 ordering information127
 wiring accessories123

accuracy

AC measurements74
 amplitude accuracy of amplifiers105
 AUX DC supply57
 CMGPS107
 CMIRIG-B109
 DC current measurement input70
 DC voltage measurement input70
 frequency measurement79
 LL outputs (SELV)53
 output power51
 phase measurement77
 power measurement80
 signal generation25

active power calculation80

address

OMICRON addresses137

altitude

max. altitude for operation65

amplifier

CMA current amplifier 105
 CMS voltage amplifier 105
 current amplifier (output) of CMC 356 22
 voltage amplifier (output) of CMC 356 21

amplifiers

ordering information 128

apparent power calculation 80

B

binary inputs

general data58, 72

binary outputs

binary output relays 1-4 56
 LL binary outputs 54

C

calibration

valid period of factory calibration 39

CAN/CSA

certified safety standards 66

CE

certified safety standards 66

cleaning of CMC 356 65

CMControl 106

CMGPS 107

ordering information 128

CMIRIG-B 109

ordering information 128

CMLIB B 118

connecting cables

how to use safely 14

ordering information 127

C

contact information	
OMICRON addresses	137
converter for fiber optics	111
counter inputs 100 kHz (LL)	61
C-PROBE1	
ordering information	128
C-Shunt (accessory)	122
current	
max. input current INPUT IDC	70
max. input current INPUT VDC	70
current clamp C-PROBE1	112

D

DC current measurement input	70
DC measurement (ANALOG DC INPUT)	70
DC voltage measurement input	70
debouncing input signals	60
deglitching input signals	60
dimensions of CMC 356	65

E

ECM-compatibility	66
electromagnetic compatibility (EMC)	66
ELT-1 option	67, 128
e-mail	
OMICRON addresses	137
EN	
certified safety standards	66
Ethernet	
Power over Ethernet	63
Ethernet cables	
ordering information	127
external interface (ext. Interf.)	54

F

fiber optics	111
FL-6 option (599 Hz restriction)	13, 41, 48, 53, 128
frequency	
output accuracy	41
output drift	41
output range settings	41
output resolution	41
front panel components of CMC 356	27
front panel control CMControl	106
fuse	
changing the	10
type	39

G

generator combination socket	
ordering information	127
voltage & current outputs	30

H

hotline	137
housing specs of CMC 356	65
humidity, relative	65

I

IEC	
certified safety standards	66
impedance	
max. input impedance INPUT IDC	70
max. input impedance INPUT VDC	70
increasing output power (operating modes)	91

I

inputs	
analog DC input UDC/IDC	69
binary inputs 1-10	58, 72
counter input 100 kHz (LL)	61
DC measurement	70
DC measurement (ANALOG DC INPUT)	70
ISO9001	
certified safety standards	66

L

LL out (SELV low level outputs)	52
LLO-2 option	90, 128

M

measurement range	
I_{DC} measurement input	70
U_{DC} measurement input	70
meter testing	
CMLIB B	118
ordering information for accessories	129

N

nominal mains current	39
-----------------------	----

O

operating temperature of CMC 356	65
optical scanning heads	
accessories	115
option	
ELT-1	67, 128
LLO-2	90, 128
options	
for CMC 356 (overview)	12
option ELT-1	67
option LLO-2	90
ordering information for CMC 356 accessories	127
OSH256	
scanning head	113
output power	
per phase when group A group B	44
voltage outputs (3-phase & single phase)	48
outputs	
current output groups A & B	43
low-level outputs (LL out)	52
serial connection CURRENT A - CURRENT B	92
voltage (technical data)	48
overheating	
of current or voltage amplifier	103
overload warning	
current amplifier	22
voltage amplifier	21

P

phase	
output error	43, 48, 53
output range	41
output resolution	41
PoE (Power over Ethernet)	63
power	
active power calculation	80
apparent power calculation	80
reactive power calculation	80
weak mains supply and output power (relation)	51
power supply range of CMC 356	25

R

reactive power calculation	80
relative humidity	65
resolution	
current outputs	43
LL out 1-6	53
phase output	41
voltage outputs	48

S

safety	
certified safety standards	66
instructions	8
use of connecting cables	14
scanning heads	
accessories	115
ordering information	129
self-test of hardware	18
SELV	
low level outputs 1-6	52
optional connector LL out 7-12	12, 90
serial connection CURRENT A - CURRENT B	92
shock and vibration (technical data)	65
shutdown due to overheating	103
signal generation	25
standards	
certified safety standards	66
storage temperature	65
supply voltage and output power (relation)	51
synchronization via GPS	36, 107
synchronized operation	41
system components of CMC 356	13

T

Technical Support	137
temperature	
operating temperature of CMC 356	65
storage temperature	65
temperature drift of output signals	41
test	
hardware self-test	18
test leads	
accessories	123
Test Universe software	7
TK 326	
scanning head	115
Trigger on overload (current outputs)	43
TVS 6.15/1	
scanning head	116

U

UL	
certified safety standards	66

V

vibration	65
voltage	
max. input voltage INPUT VDC	70
voltage outputs (technical data)	48

W

weak mains supply and output power (relation)	51
Web site	
OMICRON Web site	137
weight of CMC 356	65
wiring accessory package (ordering information)	124